

Smart Wireless System in Fiber to the Home

Mohammad Syuhaimi Ab-Rahman, Mastang,
Kamarulzaman Mat and Kasmiran Jumari
Department of Electrical, Electronics and Systems Engineering,
Faculty of Engineering and Build Environment,
University Kebangsaan Malaysia, 43600 UKM Bangi, Selangor, Malaysia

Abstract: Problem statement: Fiber To The Home (FTTH) is optical network that play important role to carry multimedia service to customers. The failure service caused by fiber optic cut or device malfunction always happens and it cannot be avoided. **Approach:** To solve the failure efficiently and effectively, it is needed a real time monitoring system that can work automatically to detect the failure and perform restoration. Smart wireless system is built to perform this task. It can monitor the optical signal continuously and perform restoration fast. Tapping method is used to take a small part of optical signal that goes to customers. This small amount of optical signal will be processed by converter and microcontroller for monitoring and restoration purpose. **Results:** Based on our experiment, the best coefficient coupler in this system is 0.1 with the receiver sensitivity 32 dBm. This system also is capable to detect the amplitude of video signal synchronous by real time. **Conclusion:** The proposed system is the first reported up to this time using RF signal to monitor the optical signal and perform automatic restoration.

Key words: Fiber To The Home (FTTH), Optical Line Terminal (OLT), Central Office (CO), Optical Network Unit (ONU), Amplitude Modulation (AM), Frequency Modulation (FM), Signal Noise to Ratio (SNR)

INTRODUCTION

Optical communication systems have begun to be developed by many researchers after finding that the use of copper cable has many disadvantages. These disadvantages include low bit rate, very limited bandwidth and high possibility of influence of magnetic field. The use of fiber optic instead copper cable can solve these problems. Fiber optic can carry data at high speed with large bandwidth. The data carried by light thus the data destruction caused by the influence of magnetic fields can be avoided.

FTTH-PON is an optical communication system that is used to carry communications signals over fiber optic cables from Optical Line Terminal (OLT) in Central Office (CO) to all customers. All communication signals are sent to all customers over single optical cable, connectors and optical splitter in distance not exceed 20 km. In customer side, optical signal will be converted to electrical signal using Optical Network Unit (ONU) (Koonen, 2006).

The ability of Fiber To The Home (FTTH) to carry 3 data services (audio, video and internet) to customers has been evidenced and implemented in Malaysia (Tan and Fain, 2009). FTTH-PON is Point-to-Multipoint (P2MP) optical network passive where "passive" means that this system only use passive components from CO to customers so that it can decrease installation cost and reduce the possibility of component damage (Radzi *et al.*, 2009). There is no active component so that the using of power supply and heating can be avoided (Khairi *et al.*, 2009). FTTH-PON consists of Optical Line Terminal (OLT) located in Central Office and some ONUs in customer side. Sending the signal to many customers only need passive component of optical splitter (Radzi *et al.*, 2009). The P2MP architecture can minimize the usage of fiber in network. Besides that, this architecture is easy to be control and might increase the number of investment in FTTH (Khairi *et al.*, 2009).

FTTH-PON architectures is capable of serving a large number of customers, so if there is a failure in the network, it may affect all customers or part of it

Corresponding Author: Mohammad Syuhaimi Ab-Rahman, Department of Electrical, Electronics and Systems Engineering, Faculty of Engineering and Build Environment, University Kebangsaan Malaysia, 43600 UKM Bangi, Selangor, Malaysia

depending on where the location of such damages. In (Chan *et al.*, 1999) said that if a failure occurs in feeder region, it can affect all networks so that all customers cannot receive the optical signal. If the failure occurs in distribution line side, only some customers will be affected (Lee *et al.*, 2006).

Some optical line failure is caused by earthquake, construction activities that cause the fiber cut, sabotages and optical device failure. Optical damage might cause the customers unable to receive service from provider in a long time. This is caused the engineers must find the failure location and fix it. All failures occur in optical network will be a business losses for service provider. This study discusses about an automatic monitoring and controlling system in FTTH based on smart wireless system so that all failures will be solved fast and efficiently. This will give many advantages both service provider and customers. Moreover, it can protect the human eye from optical leakage.

MATERIALS AND METHODS

Generally, the fiber optic monitoring system uses the optical signal to check the quality of the video signal sent from Central Office. When there is a failure in optical network, service provider operator will perform switching either manually or automatically. It is not effective because the quality of video signal is not always directly proportional to the optical loss. Figure 1 shows the comparison of communication system using AM, FM and digital method.

In communication system using Amplitude Modulation (AM), the optical loss is directly proportional to SNR of video signal. The higher optical loss, the SNR value will decrease. In this method, the optical signal can be used as an indicator that representing the quality of video signal so that the controlling of the optical lines can be done by monitoring the loss of optical signal.

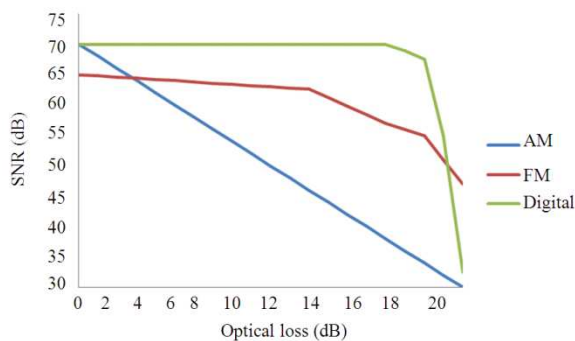

Fig. 1: Comparison of communication system using AM, FM and digital method

In communication system using Frequency Modulation (FM), the optical loss is not directly proportional to SNR of video signal so that the optical line controlling cannot be done by monitoring the quality of optical signal. Basically, the minimum requirement for good quality of video signal is 47 dB SNR. Figure 1 shows that the quality of video signal will decrease when the loss of optical power above 18 dB. On digital system, the quality of video signal will decrease when the loss of optical power above 19 dB. This means that the FTTH controlling system based on monitoring the quality of optical signal cannot be used to perform the switching process. On the other hand, the quality of video signal is not only affected by loss of optical power but also is caused by nonlinear system in optical communication.

In this study, video signal is used as indicator on automatic switching process in FTTH network. Recovery system will work when the quality of video signal decrease. When there is a loss in optical line, this system will not perform recovery process until the value of SNR below 47 dB.

To design video signal detector, PAL/NTSC detector is used after demodulator. Demodulator will convert the Radio Frequency (RF) signal to composite video signal. Composite video signal will go to PAL/NTSC detector and out binary data based on the presence of composite video signal in its input. Figure 2 shows the block diagram of video signal detector in optical network.

Video signal detector consists of passive optical components, converter, demodulator, video detector, controller, RF transmitter and optical switch. Passive optical functions to split the optical signal based on certain wavelength and ratio. Converter is CATV receiver that has function to convert the optical signal to RF signal.

This converter has sensitivity that can be chosen based on the sensitivity of photo detector. The output of PAL/NTSC detector is binary data so that it can be easy proceed by microcontroller. Type of microcontroller used is ATTiny2313 since it is small and high performance. When there is a failure in optical network, the microcontroller will send information to Central Office over RF transceiver. Central Office will check the validity of the data and determine whether need to perform restoration or not. When there is a restoration data, the engineer in CO will send information to RF transceiver and microcontroller will activate the optical switch to divert the optical signal from main line to protection line.

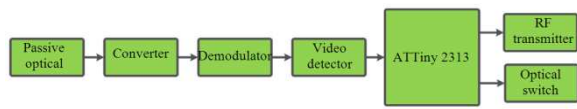

Fig. 2: Block diagram of video signal monitoring in FTTH

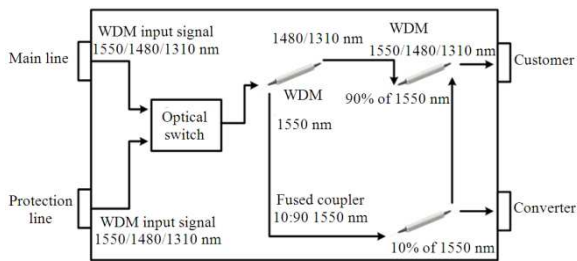

Fig. 3: Passive optical system

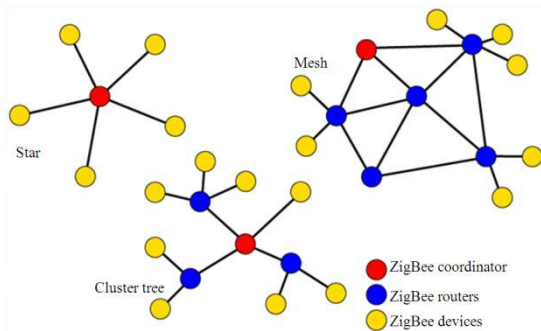

Fig. 4: ZigBee network topologies (Meshnetics, 2009)

In FTTH, Central Office will send 3 data i.e., video, audio and internet. The video signal will be carried by wavelength 1550 nm, audio 1310 nm and internet 1480 nm. The passive optical system as shown in Fig. 3, the optical signal will enter to optical switch first. Where the failure occurs in main line, the optical switch will divert the optical signal to protection line. Optical switch output will go to WDM multiplexer that has function to split the three wavelengths. Wavelength 1550nm that carries video signal will go to fused coupler that has function to split the wavelength based on ratio. 10% of the optical signal (1550 nm) will go to converter for further process as shown in Fig. 2 and 90% will go to WDM Demultiplexer to be recombined with wavelength 1480 and 1310 nm.

To perform smart monitoring in optical network, we use zigbee solutions. ZigBee is a wireless networking standard, aimed at remote control and sensor applications which are suitable for operation in harsh radio environments and in isolated locations. It

builds on IEEE standard 802.15.4 which defines the physical and MAC layers. The IEEE 802.15.4 protocol presents some potentially interesting features for supporting large-scale computing applications. The IEEE 802.15.4 protocol, adopted as a communication standard for Low-Rate Wireless Local Personal Area Networks (LR-WPANs) (Callaway *et al.*, 2002).

Even though it was not specifically designed for WSNs, this protocol provides enough flexibility for fitting different requirements of WSN applications by adequately tuning its parameters. WSN consists of many distributed and disposable sensor nodes that require a highly integrated, low cost single chip transceiver with high energy efficiency. To consume less power it should work at a low duty cycle (Ab-Rahman *et al.*, 2011). In fact, low rate, low-power consumption and low-cost wireless networking are the key features of the IEEE 802.15.4 protocol, which typically fit the requirements of WSNs.

The protocol is very important for wireless network. So protocols are designed to optimize the number of bytes transmitted/received in the network for the intended communication. Often energy efficiency is dealt in the Medium Access Control (MAC) layer in the protocol for wireless sensor network by introducing sleep schedule. Another way of reducing the energy consumption without increasing the end to end latency is the Transmission power control. Nowadays many transceivers have the ability to change their transmission power dynamically by changing the amplifier gain setting (Najashi and Xiaoheng, 2011).

As shown in Figure 4, there are three different network topologies that are supported by Zigbee, namely the star, mesh and cluster tree or hybrid networks. Each has its own advantages and can be used to advantage in different situations. The star network is commonly used, having the advantage of simplicity. As the name suggests it is formed in a star configuration with outlying nodes communicating with a central node. Mesh or peer-to-peer networks enable high degrees of reliability. They consist of a variety of nodes placed as needed and nodes within range being able to communicate with each other to form a mesh. Messages may be routed across the network using the different stations as relays. There is usually a choice of routes that can be used and this makes the network very robust. If interference is present on one section of a network, then another can be used instead (Meshnetics, 2009).

ZigBee uses 2 kinds of addressing, 64 bit IEEE address and a 16 bit short address. In this research, we use XBee-PRO module. XBee-PRO RF Modules were engineered to meet IEEE 802.15.4 standards and support the unique needs of low-cost, low-power wireless sensor networks.

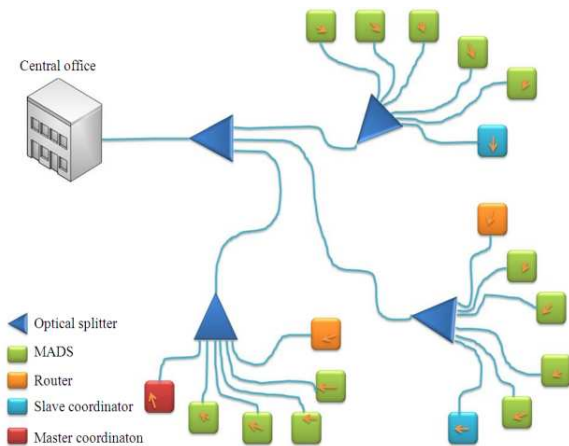

Fig. 5: ZigBee network configuration in FTTH

The modules require minimal power and provide reliable delivery of data between devices. The modules operate within the ISM 2.4 GHz frequency band and are pin-for-pin compatible with each other.

Figure 5 shows the configuration of zigbee network in FTTH. Each optical splitter consists of 6 sensors and one sensor will be used as coordinator. Coordinator is capable to scan all sensors in its group and make communication with another group or central office. Two classes of devices are employed, one XBee and the other XBee-Pro. The XBee has the maximum indoor/urban range of 30 m and Outdoor Range of 100 m, operating at 2.4 GHz frequency with data rate of 250 Kbps. XBee-Pro has the same specifications except that its indoor/urban range is 100 m and outdoor line-of-sight range is up to 1.6 km. This design employed a mesh network configuration. We use Xbee-Pro as coordinator and receiver in Central Office while others using XBee.

Many ZigBee hardware solutions employ 2.4GHz frequency band. ZigBee's packet has a maximum size of 128 bytes including protocol overhead with effective room for a maximum of 104 bytes of data.

RESULTS AND DISCUSSION

Experiment has been done in Spectech Laboratory, Universiti Kebangsaan Malaysia to determine the performances of this monitoring system. Figure 6 shows the equipments used in this experiment.

DVD player is used as video signal source and will be converted to RF signal by using RF converter. To play many channels, we put 4 DVD players and 4 RF converters that will be combined by using RF combiner before they are modulated by optical signal.



Fig. 6: Experiments in lab spectech

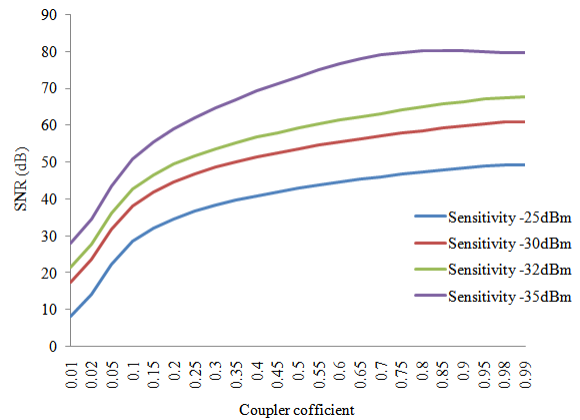

Fig. 7: Effect of fused coupler coefficient to SNR

Transmitter has function to convert the RF signals to optical signals and transmit them over 20 km optical cable. To distribute the signals to some customers, optical splitter is needed. In this experiment, we use optical splitter 1x8 to split the signal to eight customers. Smart wireless system will be put before Optical Network Unit (ONU).

Figure 7 shows the fused coupler characteristic in FTTH using optical splitter 1x8. By using converter with sensitivity -30 dBm, the Signal Noise to Ratio (SNR) above 30dB can be obtained by using fused coupler with coefficient 0.1. By using converter with sensitivity -32 dBm, the Signal Noise to Ratio (SNR) above 30dB can be obtained by using fused coupler with coefficient 0.05. And by using converter with sensitivity -35 dBm, the Signal Noise to Ratio (SNR) above 30dB can be obtained by using fused coupler with coefficient 0.02.

Figure 8 shows the effect of fused coupler coefficient to video signal synchronous amplitude. Either in PAL or NTSC system, synchronous is a signal that indicates a new frame received by television.

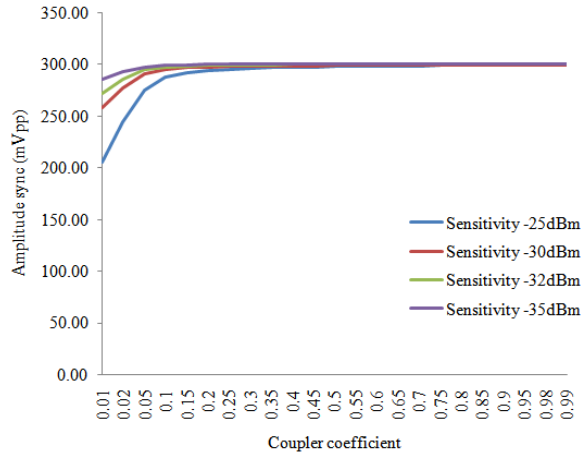

Fig. 8: The effect of fused coupler coefficient to video signal synchronous amplitude

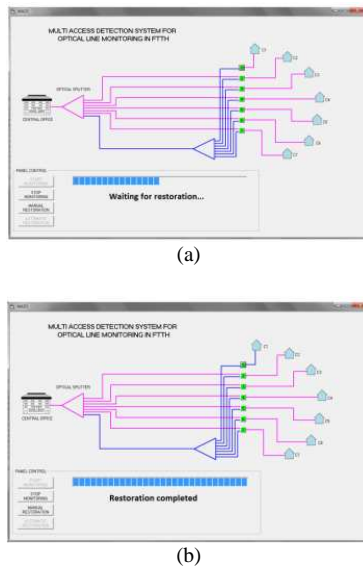

Fig. 9: (a) Restoration process in FTTH (b) Restoration completed in FTTH

Synchronous signal will be put at the end of every frame of video. The amplitude of synchronous signal is 287 mV for PAL format and 300 mV for NTSC. PAL/NTSC detector is capable to detect the synchronous signal where its amplitude greater than or equal to 250 mV. By using converter with sensitivity -25 dBm as shown in Fig. 8, the amplitude sync of video signal 274 mVpp can be obtained by using fused coupler with coefficient 0.05. By using converter with sensitivity -30, -32 and -35 dBm, the amplitude sync of video signal 258 mVpp, 272.10 mVpp and 285.72 can be obtained by using fused coupler with coefficient 0.01.

At Central Office, the engineer can observe the condition of all optical lines visually. Graphical User Interface (GUI) has been built by using Visual Basic Programming. Figure 9a and b shows the GUI for monitoring and restoration process.

CONCLUSION

Optical signal monitoring system by using video signal indicator has been developed. This system is capable to monitor the condition of all optical lines continuously without controlling manually from Central Office. This system only uses photo detector with sensitivity 32 dB and fused coupler with coefficient 0.1. This means it only takes 10% of optical signal sent from Central Office whereas the remaining 90% will go to customer so that it will not affect the data traffic.

REFERENCES

- Ab-Rahman, M.S., Mastang and K. Jumari, 2011. The influences of connectors and adaptors to fiber-to-the-home network performance. Am. J. Applied Sci., 9: 186-195. DOI: 10.3844/ajassp.2012.186.195
- Callaway, E., P. Gorday, L. Hester, J.A. Gutierrez and M. Naeve *et al.*, 2002. Home networking with IEEE 802.15.4: A developing standard for low-rate wireless personal area networks. IEEE Commun. Mag., 40: 70-77. DOI: 10.1109/MCOM.2002.1024418
- Chan, C.K., F. Tong, L.K. Chen, K.P. Ho and D. Lam, 1999. Fiber-fault identification for branched access networks using a wavelength-sweeping monitoring source. IEEE Photonics Technol. Lett., 11: 614-616. DOI: 10.1109/68.759416
- Khairi, K., Z.A. Manaf, D. Adriyanto, M.S. Salleh and Z. Hamzah *et al.*, 2009. CWDM PON system: Next generation PON for access network. Proceedings of the IEEE 9th Malaysia International Conference on Communications (MICC), Dec. 15-17, IEEE Xplore Press, Kuala Lumpur, pp: 765-768. DOI: 10.1109/MICC.2009.5431392
- Koonen, T., 2006. Fiber to the home/fiber to the premises: What, where and when? Proc. IEEE, 94: 911-934. DOI: 10.1109/JPROC.2006.873435
- Lee, K., S.B. Kang, D.S. Lim, H.K. Lee and W.V. Sorin, 2006. Fiber link loss monitoring scheme in bidirectional WDM transmission using ASE-injected FP-LD. IEEE Photonics Technol. Lett., 18: 523-525. DOI: 10.1109/LPT.2005.863991

- Meshnetics, 2009. Zigbee Faq: What topologies are supported by ZigBee.
- Najashi, B.G. and T. Xiaoheng, 2011. A comparative performance analysis of multiple-input multiple-output using MATLAB with zero forcing and minimum mean square error equalizers. *Am. J. Eng. Applied Sci.*, 4: 425-428. DOI: 10.3844/ajeassp.2011.425.428
- Radzi, N.A.M., N.M. Din, M.H. Al-Mansoori, I.S. Mustafa and S.K. Sadon, 2009. Efficient dynamic bandwidth allocation algorithm for upstream EPON. *Proceedings of the IEEE 9th Malaysia International Conference on Communications (MICC)*, Dec. 15-17, IEEE Xplore Press, Kuala Lumpur, pp: 376-380. DOI: 10.1109/MICC.2009.5431534
- Tan, A. and Fain, 2009. FTTH in Malaysia. The Danesh Project.