

A Novel Navigation Algorithm for Hexagonal Hexapod Robot

¹Mohiuddin Ahmed, ²Md. Raisuddin Khan, ³Md. Masum Billah and ³Soheli Farhana
¹Department of Computer Science, Faculty of Information and Communication Technology,
²Department of Mechatronics Engineering, Faculty of Engineering,
³Department of Electrical and Computer Engineering, Faculty of Engineering,
International Islamic University Malaysia, Malaysia

Abstract: Problem statement: Wheeled robots are not very well suited for navigation over uneven terrains. Hexapod robots have some advantages over wheeled robots when negotiating and navigating on rugged terrain. **Approach:** Different gaits of hexapods can be developed for different kinds of locomotion and obstacle avoidance. **Results:** In this research a novel algorithm has been developed for hexapod robots navigation. **Conclusion:** Implementation of the developed algorithm on a hexapod prototype showed desirable performance in terms of stable navigation with simultaneous gait transition over different terrains.

Key words: Hexapod robot, rugged terrain, navigation and gait transition

INTRODUCTION

Legged robots are preferred over the wheeled counterpart for their advantages in navigating rugged terrain. During the past few decades, many legged robots have been built in the laboratory. Depending on design, they have had a number of legs ranging from 2 to 8. Methods of control depend on the geometry as well as the number of legs attached to a robot. A six-legged robot, or hexapod, for example, seems to attract more attention compared to other robots because it easily achieves static stability during walking. Some researchers (Todd, 1985); believed that the use of hexapod robots would provide a more robust platform for applications, since it can support more weight than bipeds or quadrupeds. Examples of application of hexapod robots include the walking manipulator (Schraft *et al.*, 2000); inspection and construction robots, rosy I and II (IEEE and Fraunhofer, 2008); and aquarobot for underwater operation (Akizono *et al.*, 1997). The gait control problem of a hexapod is an extensively studied subject. (McGhee and Iswandhi, 1979); has established many basic terminologies for gait analysis. Bessonov and Umnov (1973) developed hexapod motion in straight lines and Song and Waldron (1989) made a survey on gait study. Yang and Kim (1998) have mathematically proved that a fault-tolerant gait with sensible stride length for a hexapod robot can made stable navigation on even terrain. Later the fault tolerant gait was developed (Yang and Kim, 1999) for

uneven terrains. However, all gaits were urbanized based on rectangular base model with a limited robot design. Some researches have been done on hexagonal hexapod robots (Baudoin and Alexandre, 1995; Tanaka and Matoba, 1991; Techn, 2008; Bartholet, 1983). A hexapod robot with hexagonal architecture has advantages in turning gait (Preumont *et al.*, 1991) but the rotation of a robot is based on crab gait, which is unstable in navigating over rugged terrain. In this paper, we have presented gait analysis of a hexagonal hexapod robot for navigating on even as well as on uneven terrains. In order to navigate on complex terrains, a novel algorithm is developed based on the gait transition.

MATERIALS AND METHODS

Experimental setup:

Body configuration: A hexapod robot is a perfunctory medium that walks on six legs. Since a robot can be statically secure on three or more legs, a hexapod robot has a great deal of suppleness in how it can move. If only few legs become disabled, the robot may still be able to walk. Furthermore, all legs are needed for stability; other legs are free to reach new foot placements or manipulate a payload. Hexapod robots obtain more speed than quadruped ones with a statically stable gait in the navigation (Gonzalez *et al.*, 2007). However, the robot's static stability margin is not optimum when using gaits, for instance, five-leg support patterns.

Corresponding Author: Mohiuddin Ahmed, Department of Computer Science, Faculty of Information and Communication Technology, International Islamic University Malaysia, Malaysia

In this research a hexapod with regular hexagonal base with a circular body configuration that looks like a spider as shown in Fig. 1 is chosen to try to increase the speed, albeit at the cost of slightly jeopardizing its stability. The six legs are attached to the body at each corner of the hexagon. Such a hexapod is able to navigate in rugged terrain. It contains required subsystems, such as an onboard computer, electronics, and drivers, a PIC Micro controller, LCD and batteries.

The maximum moveable area (shadow) and the actual moveable area (rectangular) of each leg are shown in Fig. 2. Each leg has a moveable area in the form of an annulus of radius r_{max} . The actual moveable area is determined in such a way that there are no collisions in between the lags. Figure 3 shows the hexapod robot model. One of the legs is set as a reference and the other legs are numbered counterclockwise starting from the reference leg, as shown in Fig. 3.

The size of the moveable area (McGhee and Iswandhi, 1979), P and Q with r_{max} and r_{min} is shown in the Fig. 2 and 5:

$$r_{max}^2 = (r_{min} + Q) + (\frac{1}{2}P)^2 \tag{1}$$



Fig. 1: Body of hexapod robot

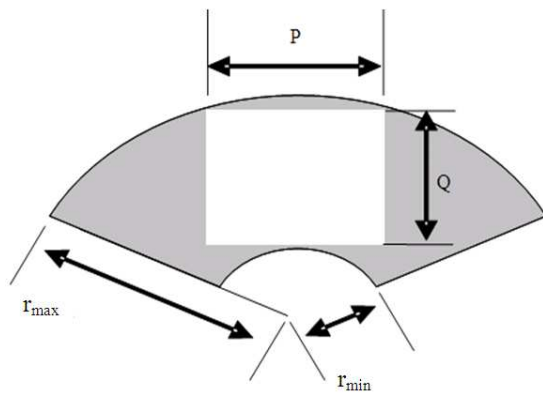

Fig. 2: Relationship between the reachable area and annulus

Leg configuration: Legs have been designed taking into consideration the weight of the robot along with its subsystems as well as the weight of the legs. Spider-like leg configurations are typical for walking robots. It is known that a spider-like leg configuration is the most efficient one from the energy point of view and it requires joint torques (Seyfarth *et al.*, 2007). However, it is not very efficient in terms of stability. Energy efficiency being a very important factor for outdoor mobile robots, spider-like leg configuration is chosen for accomplishing its job with both stability and energy efficiency. Three servomotors are used in each leg as shown in Fig. 4. The servomotors at joints 2 and 3 are able to rotate about two horizontal axes. However, the third one used at joint 1 is able to rotate about a vertical axis only.

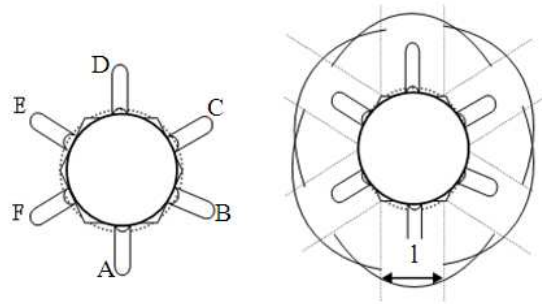

Fig. 3: Hexapod model

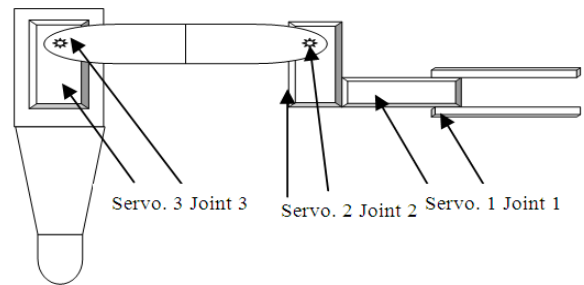

Fig. 4: Leg configuration

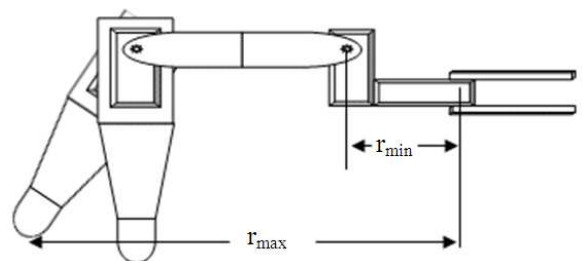

Fig. 5: Leg reachable area

Gait design:

Tripod gait for even terrain: The tripod gait is the best-known hexapod gait. A tripod consists of the front-back legs on one side and the middle leg on the opposite side. For each tripod, the legs are lifted, lowered and moved forwards and backwards in unison. During walking mode, a hexapod uses its 2 tripods unlike a bi-pad stepping from one foot to the other; the weight is simply shifted alternately from one tripod to the other. Since 3 legs are on the ground at any point of time, this gait is both “statically” and “dynamically” stable. The movement scheme is easily visualized by examining Fig. 6; the numbers adjacent to the legs in the body diagram correspond to time points on the graph. The leg coordination of walking spiders appears to be quite regular too and is described by the so-called tripod gait (Ahmed *et al.*, 2009).

Wave gait for even terrains: In the wave gait, all legs on one side are moved forward in succession, starting with the rear most leg. This is then repeated on the other side. Since only 1 leg is ever lifted at a time, with the other 5 being down, the robot is always in a highly-stable posture. One conjecture is that the wave gait cannot be sped up too much. The wave gait pattern is chosen in this system because it provides the maximum stability margin for uneven terrain. The control algorithm is used for the control action of wave gait locomotion with an angular position input (Inagaki and Kobayashi, 1994). The foot is commanded to move forward a constant length at each integral time interval as showing in Fig. 7.

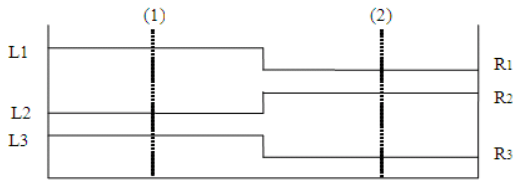

Fig. 6: Stepping patterns of swing movements

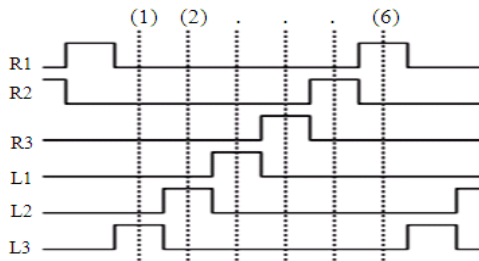

Fig. 7: Stepping patterns of swing movements for wave gait (Ahmed *et al.*, 2009)

Stride length: The maximum stride length for a hexagonal model is equal to $\frac{1}{2}r_{max}$.

$r_{max} > P$ achieve a greater stride length for a hexagonal hexapod robot.

From Eq. 1:

$$\begin{aligned} r_{max}^2 &> P^2 \\ \Rightarrow (r_{min} + Q)^2 + (\frac{1}{2}P)^2 &> P^2 \\ \Rightarrow (r_{min} + Q)^2 &> (\frac{3}{4}P^2) \end{aligned} \tag{2}$$

We assume Y is the distance between the hexapod body and moveable area:

$$\therefore r_{min} = Y$$

If $r_{min} = 0, Y = 0$, then the kinematic structure of the hexapod is located outside of the body.

If $r_{min} < 0, Y < 0$, then the kinematic structure of the hexapod is located below the body.

Let $r_{min} = 0$, from Eq. 2:

$$\begin{aligned} (r_{min} + Q) &> (\frac{\sqrt{3}}{2}P) \\ \Rightarrow Q &> 0.886P \\ \Rightarrow \frac{Q}{P} &> 0.886 \end{aligned} \tag{3}$$

Equation 3 proves that the hexagonal model has a great stride length.

Turning ability: Based on turning centre, a hexapod robot can be turned in any direction (Zhang *et al.*, 1991). The centroid of the body is the turning centre as declared in this study. The legs’ footholds are in the centroid of the moveable area after turning which is considered a maximum turning of the hexapod in every step. The turning step is shown in Fig. 8 with angle \emptyset . The hexapod position vector of the centroid should be $O (O_x, O_y)$, and the origin of the position vector of the joint of each leg and the body should be $BO_i (BO_{xi}, BO_{yi})$ (where $i = 1, 2, 3, 4, 5, 6$).

Scenarios of hexapod: Figure 9 shows the state diagram of random scenarios of the hexapod robot. This state diagram is constructed from the state table shown in the Table 1. In the state diagram all states including the actions to be executed and the actions performed by it are shown.

Table 1: State table for random scenarios

State	Event	Actions	Comment	Caused by	Will effect
A. Active	1. Turn on	Boot up	Hexapod is turning on		2-10
	2. Boot up	Activity	Allow various activities	1	3-8
	3. Forward movement	Walk forward	Hexapod will begin to walk forward	2	11, 12
	4. Backward movement	Walk backward	If obstacle is in front, hexapod will begin to walk backward		12
	5. Right rotation	Rotating in right side	If obstacle is left side, hexapod will turn by 90° angle in right direction		12
	6. Left rotation	Rotating in left side	If obstacle is right side, hexapod will turn by 90° angle in left direction		12
	7. Sensor2 press	Button on	No ditch obstacle		11
	8. Sensor2 not press	Button off	Ditch obstacle found		12
	9. Sensor1 press	Button on	Hill obstacle found		12
	10. Sensor1 not press	Button off	No obstacle		11
B. Even terrain	11. Tripod gait	Fast movement	Hexapod will walk or rotate very fast until it gets an obstacle	7, 10	3
C. Uneven terrain	12. Wave gait	Slow movement	Hexapod will walk or rotate at a snail's pace for t sec.	8, 9	3, 4, 5, 6
	13. Stop and wave backward	No surface	Hexapod will walk backward and rotate	8	4, 5, 6
	14. Stop and wave forward	Surface available with 1" ditch	Hexapod will walk forward slowly	7, 8	3, 12

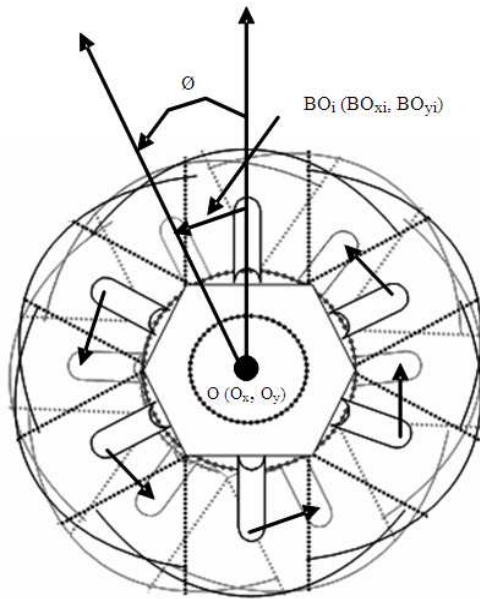

Fig. 8: Turning step for hexapod model

Steps of algorithm:

1. Idle mode
2. Call turn_on procedure
3. **Active state:**
 - a. Move_forward
 - b. Move_backward
 - c. Turn_left
 - d. Turn_right
 - e. Sensor_1 (on/off)
 - f. Sensor_2 (on/off)

- g. T_gait
- h. W_gait
- i. Timer_on

4. Uneven terrain state:

- a. Timer_on
- b. W_gait
- c. Move_forward
- d. move_backward
- e. Turn_left
- f. Turn_right

5. Even terrain state:

- a. T_gait
- b. Move_forward

Gait transition methods: Gaits are meant to be run indefinitely; transitions are finite behaviors that switch between gaits. In order to generate automated useful transitions, it is important to understand the fundamental properties of gaits as well as their stable configuration.

Gait transition: A gait transition method is realized by stepping on the spot which shows high stability (Adachi *et al.*, 1998). A robot stops on the spot and a leg moves to the position of new gait stepwise, which takes 4 cycles to complete the gait transition for the quadruped robots. In this study, a new method is derived for hexapod gait transition. The gait transition in between tripod gait to wave gait and wave gait to tripod gait begins at the triangular position to pentagonal position, called Triangular Pentagonal Exchange point (TPE) and vice versa (PTE) respectively. In this method, the robot stops to move at TPE point and switches legs for gait transition with any state of the legs.

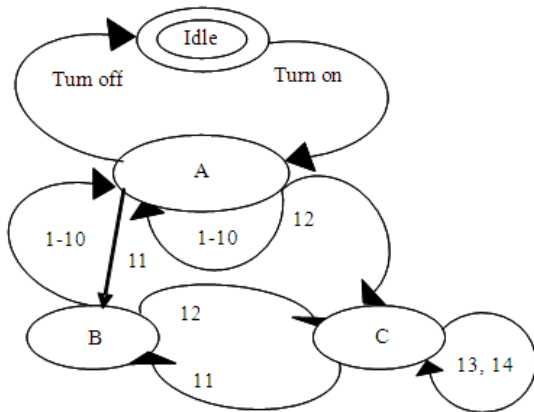

Fig. 9: State diagram for random scenarios

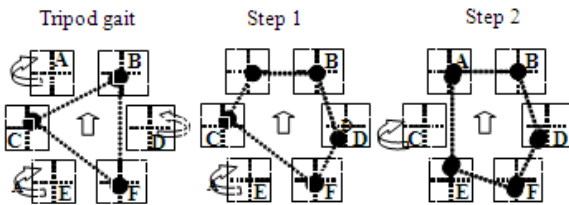

Fig. 10: Gait transition from tripod to wave gait case 1

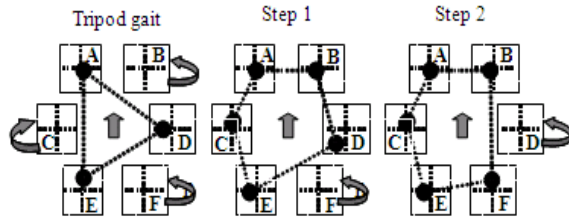

Fig. 11: Gait transition from tripod to wave gait case 2

Typical gait transition method: There are different ways of gait transition according to the state of each leg. In our method the gait transition starts at the TPE point and every transition considers two cases. Case 1: One of the swing legs of the current gait will become the front leg as a first swing leg in the new gait or Case 2: The rear leg will be the first leg. There are two steps in each case during every gait transition. The leg posture indicated as Step 1 is the leg arrangement when the gait transition starts and in Step 2, the swing leg is located on the new gait position. Figure 10 shows position of the legs in a particular posture.

Transition from tripod gait to wave gait: The transition from tripod gait to wave gait is implemented using TPE point. The method of gait transition is described in the following steps.

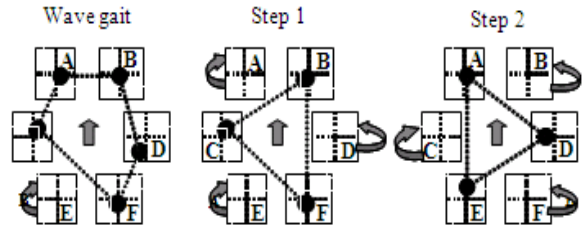

Fig. 12: Gait transition from wave to tripod gait case 1

Case 1: In Fig. 10, leg E is the first leg to contact the ground during gait transition out of the swing legs A, D and E. In Step 1, the robot is in the TPE point and the leg E moves to the supporting position of the new gait. In Step 2, the legs A, B, D, F and E keep their stable position and the leg C becomes the swing leg. In this state the robot keeps the position for $1/6 T$ after support phase begins (T is the period of one cycle); (Toyama and Ma, 2002).

Case 2: In Fig. 11, leg F becomes first leg from swing legs B, C and F during gait transition. In the Step 1, the robot is in the TPE point. The swing legs B, C move to the supporting position of the new gait and the leg F becomes the swing leg and moves to the new gait position while the robot is in the same position. Then F, B, A, C and E keep a grounded contact and D becomes the swing leg. Thus the legs are consecutively following wave gait order as B, A, C and E for swing and the robot is in this same position for $1/6 T$.

Transition from wave gait to tripod gait: The transition from wave gait to tripod gait is implemented using PTE point.

The method of gait transition is described in the following steps:

Case 1: If the leg A, E or D is the swing leg then A, E and D become first swing legs for the new tripod gait. In Fig. 12, leg E is considered as a swing leg in wave gait. In Step 1, the robot is at the TPE point and the legs B, C and F move to the supporting position of the new gait. In this posture the legs A, E and D keep their positions in contact to the ground and the legs B, C and F become the swing legs in Step 2. Therefore the robot keeps this position for $3/6 T$.

Case 2: If the leg B, C or F is the swing leg then B, C and F become first swing legs for the new tripod gait. In Fig. 13, leg B is considered as a swing leg in wave gait.

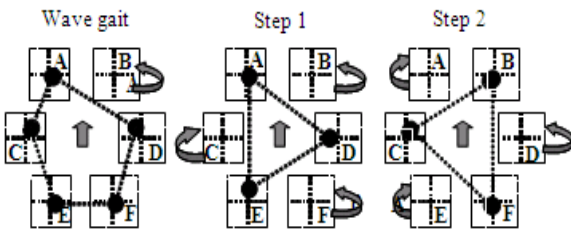

Fig. 13: Gait transition from wave to tripod gait case 2

In the Step 1, the robot is at the TPE point and the swing legs B, C and F move to the supporting position of the new gait. In the next step the legs A, D and E become swing legs and move to the new gait position and the robot keeps the stable position in the Step 2. Therefore the legs follow tripod gait with leg stepping and the robot keeps the same position for 3/6 T.

Transition method algorithm:

Steps of algorithm:

Initialization

$L \leftarrow \{A, B, C, D, E, F\}$

$Lt1 \leftarrow \{A, D, E\}$

$Lt2 \leftarrow \{B, C, F\}$

$Lw1 \leftarrow \{A | D | E\}$

$Lw2 \leftarrow \{B | C | F\}$

Os Obstacle state

Ns Non obstacle state

Active mode

Tripod gait

Tripod to wave gait transition:

While (Os) do

- Case_1:
 - If (swing_leg (Lt1)) then
 - Step 1-
 - ground_contact (Lt1-1)
 - where $\{A, D\} \in (Lt1-1)$
 - Step 2-
 - stable_condition (L-1)
 - and swing_leg (L-5)
 - where $\{A, B, D, F, E\} \in (L-1)$ and $\{C\} \in (L-5)$
 - wave_gait (L)
 - End if
- Case_2:
 - If (swing_leg (Lt2)) then
 - Step 1-
 - ground_contact (Lt2-1)

where $\{B, C\} \in (Lt2-1)$

Step 2-
 stable_condition (L-1)
 and swing_leg (L-5)

where $\{B, A, C, E, F\} \in (L-1)$ and $\{D\} \in (L-5)$

wave_gait (L)

Wave to tripod gait transition:

While (Ns) do

- Case_1:
 - If (swing_leg (Lw1)) then
 - consider $\{E\} \in (Lw1)$
 - Step 1-
 - swing_leg (Lt1-1)
 - where $\{A, D\} \in (Lt1-1)$
 - Step 2-
 - stable_condition (Lt1)
 - and swing_leg (Lt2)
 - tripod_gait (Lt1, Lt2)
 - End if
- Case_2:
 - If (swing_leg (Lw2)) then
 - consider $\{B\} \in (Lw2)$
 - Step 1-
 - swing_leg (Lt2-1)
 - where $\{C, F\} \in (Lt2-1)$
 - Step 2-
 - stable_condition (Lt2) and
 - swing_leg (Lt1)
 - tripod_gait (Lt1, Lt2)
 - End if

RESULTS

We have implemented the developed algorithm to the hexapod robot. The robot has been tested and observed in the indoor environment. There are a number of scenarios from this observation; terrain negotiation & navigation with appropriate gait and gait transition to switch between different terrains. In this section the results are discussed that addresses hexapod's stable navigation for both even and uneven terrains.

The experiment shows hexapod uses tripod gait to navigate on the even terrain and wave gait to navigate over uneven terrain. Figure 14 shows the complete tested environment: the hexapod robot walks on the floor with some hill-type obstacles and navigates on the table with a ditch-type obstacle.

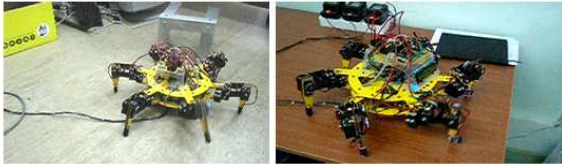

Fig. 14: Hexapod navigation over flat terrains and tables

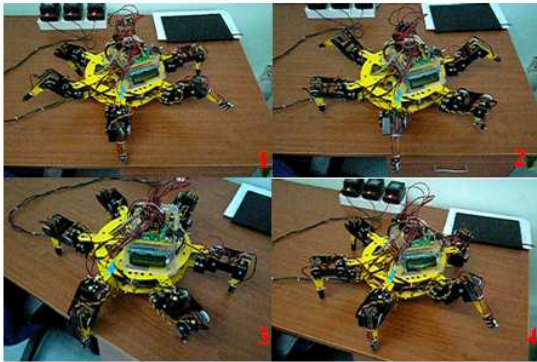

Fig. 15: Hexapod gait transition on the table

The two gaits involved in a transition from an even terrain to an uneven terrain differ in many ways, not only in gait parameters, but also in how they interact with the surface. The tripod gait is a faster gait for an even terrain navigation. Transition can be described as switching legs from one gait to another which is shown in Fig. 15. In Fig. 15 the hexapod tests out a ditch with tripod gait locomotion and then it makes a gait transition to wave gait locomotion in order to take a turn in an appropriate direction.

DISCUSSION

The transition used to switch between walking and negotiating terrains was implemented by developed algorithm, and a reactive system was implemented for semi-autonomous operation. The result of this transition, shown in Fig. 17, shows that the front left leg negotiates the obstacle (A mirror image of this transition exists when the right leg hits the obstacle). Rotation towards the right is performed on a 90° angle step. Since the robot changes gait of locomotion while it negotiates an uneven terrain, motions of the legs are changed to the wave gait from the tripod gait during the transition. Upon reaching an uneven terrain the robot launches the correct transition depending on the leg (right or left) negotiating the obstacle. A simple reactive system detects the hill or ditch through the push-button sensors attached to the front two legs.



Fig. 16: Hexapod executing the sleep mode

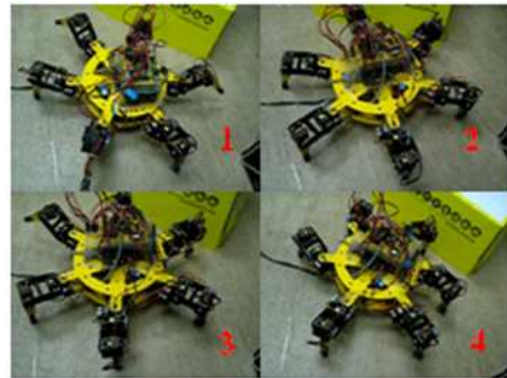

Fig. 17: Hexapod executing the gait transition 1, left leg hits an obstacle

Performance tests show satisfactory results on different terrains without any human intervention, as seen in the photos included in Fig. 17.

The robot manages its leg motions and performs simple transitions automatically whenever required, to turn or change direction. Furthermore, press of a button executes reset transitions between unfamiliar terrains. One such transition is that when the robot is picked up from the ground contact. In such case it goes to sleep mode automatically as shown in the Fig. 16.

CONCLUSION

A novel navigation algorithm is developed for a hexagonal hexapod robot that uses optimal gait for locomotion. This algorithm generates near maximal stroke tripod gait for walking on regular terrain. The problem of optimal gait generation for a six legged walking machine, the hexapod, is addressed in this research. Limits on minimum stability margin, maximum foot force, foot motion and collision between adjacent legs are considered for generating the gait. The algorithm can be used with minor modifications, for generating a regular gait like wave gait for walking on inclined planes as well as steps. We have also developed a method to perform obstacle avoidance and terrain negotiation in static uncertain environment by using different gait of locomotion with gait transition between tripod gait and wave gait.

REFERENCES

- Adachi, H., N. Koyachi, T. Arai, K. Homma and Y. Shinohara *et al.*, 1998. Semi-autonomous walking based on leg transition at the border of the leg work space. *J. Robot. Soc. Jap.*, 16: 329-336. <http://ci.nii.ac.jp/naid/10007441469/en>
- Ahmed, M., M.M. Billah, M.R. Khan and S. Farhana, 2009. Walking hexapod robot in disaster recovery: Developing algorithm for terrain negotiation and navigation. *J. World Acad. Sci. Eng. Technol.*, 42: 328-333. <http://www.waset.org/journals/waset/v42/v42-60.pdf>
- Akizono, J., T. Tanaka, K. Nakagawa, T. Tsuji and M. Iwasaki, 1997. Seabottom roughness measurement by aquatic walking robot. Proceeding of the MTS/IEEE Conference, OCEANS, Oct. 6-9, IEEE Xplore Press, Halifax, NS., pp: 1395-1398. DOI: 10.1109/OCEANS.1997.624200
- Bartholet, T.G., 1983. The first functionoid developed by ODETICS Inc. Proceeding of the International Conference on Advanced Robotics, Sept. 12-13, Robotics Society of Japan, Tokyo, Japan, pp: 293-298. <http://www.theoldrobots.com/images40/Odex1.pdf>
- Baudoin, Y. and P. Alexandre, 1995. Development of legged robots for use in disordered environments. *Proc. SPIE Mobile Robots*, 2591: 100-107. DOI: 10.1117/12.228966
- Bessonov, A.P. and N.V. Umnov, 1973. The analysis of gaits in six-legged vehicles according to their static stability. Proceeding of the Symposium on Theory and Practice of Robots and Manipulators, (TPRM'73), Elsevier, Udine, Italy, pp: 1-10.
- Gonzalez, P., J.A. Cobano, E.J. Garcia, Estremera and M.A. Armada, 2007. A six-legged robot-based system for humanitarian demining missions. *Mechatronics*, 17: 417-430. DOI: 10.1016/j.mechatronics.2007.04.014
- IEEE and Fraunhofer, 2008. IPA database on service robotics-reconstruction rosy. <http://www.ipa.fhg.de/srdatabase/rosy.html>
- Inagaki, K. and H. Kobayashi, 1994. Adaptive wave gait for hexapod synchronized walking. Proceedings of IEEE International Conference on Robotics and Automation, May 8-13, IEEE Xplore Press, San Diego, CA., pp: 1326-1331. DOI: 10.1109/ROBOT.1994.351303
- McGhee, R.B. and G.I. Iswandhi, 1979. Adaptive locomotion of a multilegged robot over rough terrain. *IEEE Trans. Syst. Man Cybernet.*, 94: 176-182. DOI: 10.1109/TSMC.1979.4310180
- Preumont, A., P. Alexandre and D. Ghuys, 1991. Gait analysis and implementation of a six leg walking machine. Proceeding of the 5th International Conference on Advanced Robotics, Robotics in Unstructured Environment, June 19-21, IEEE Xplore Press, Pisa, Italy, pp: 941-945. DOI: 10.1109/ICAR.1991.240551
- Schraft, R.D., 2000. Service Robots: Products. Scenarios, Visions. 14th Edn., A.K. Peters Ltd., Natick, MA., USA., ISBN: 1-56881-109-8, pp: 216.
- Seyfarth, A., H. Geyer, R. Blickhan and S. Lipfert *et al.*, 2007. Running and walking with compliant legs. *Collect. Eng.*, 340: 383-401. DOI: 10.1007/978-3-540-36119-0
- Song, S.M. and K.J. Waldron, 1989. Machines That Walk: The Adaptive Suspension Vehicle. MIT Press, Cambridge, MA., ISBN: 0262192748, pp: 330.
- Tanaka, Y. and Matoba, 1991. Study of an intelligent hexapod walking robot. Proceedings of the IEEE/RSJ International Workshop on Intelligent Robots and Systems, Intelligence for Mechanical Systems, Nov. 3-5, IEEE Xplore Press, Osaka, pp: 1535-1540. DOI: 10.1109/IROS.1991.174730
- Techn, S.C., 2008. Walking Robot Katharina. http://www.iff.fhg.de/iff/aut/english/start_katharina_e.html
- Todd, D.J., 1985. Walking Machine: An introduction to Legged Robots. Kogan Page, London, UK., ISBN: 0-85038-932-1, pp: 190.
- Toyama, T. and S. Ma, 2002. All-directional walking of quadruped robot base on crawl and rotation gaits. *J. Robot. Soc. Jap.*, 20: 307-314.
- Yang, J.M. and J.H. Kim, 1998. Fault-tolerant locomotion of the hexapod robot. *IEEE Trans. Syst. Man. Cybernet.*, 28: 109-116. DOI: 10.1109/3477.658585
- Yang, J.M. and J.H. Kim, 1999. Optimal fault tolerant gait sequence of the hexapod robot with overlapping reachable areas and crab walking. *IEEE. Trans. Syst. Man. Cybernet.*, 29: 224-235. DOI: 10.1109/3468.747858
- Zhang, C.D. and Song, S.M. Turning, 1991. Gait of a quadrupedal walking machine. Proceeding of the IEEE International Conference on Robotics and Automation, Apr. 9-11, IEEE Xplore Press, Sacramento, CA., USA., pp: 2106-2112. DOI: 10.1109/ROBOT.1991.131938