

Control Strategy for Discontinuous Conduction Mode Boost Rectifier with Low Total Harmonic Distortion and Improved Dynamic Response

H.S. Athab

Faculty of Engineering, Multimedia University, 63100 Cyber Jaya, SEL Malaysia

Abstract: Due to its simplicity, the discontinuous conduction mode boost rectifier is potentially the least expensive active line-harmonics reducing circuit. **Problem statement:** The line current however, shows considerable distortion when the peak input voltage is close to the output voltage, As a result, the input power factor is poor. This study proposes a simple, low-cost method to reduce the line harmonics. **Approach:** A periodic voltage signal was injected in the control circuit to vary the duty cycle of the boost switch within a line cycle so that the third-order harmonic of the input current is reduced and the THD is improved. The proposed technique eliminates the additional harmonic generator, phase detecting and phase-locking circuits, which was proposed in the literature. Instead we can utilize the bridge rectifier's output voltage of the boost converter to modulate the duty cycle of the boost switch. As a result, the injected signal is naturally synchronized with line current. In addition, to obtain nearly constant harmonic content over a wide range of load variation, a modulation index m is used to update the injected signal with a fraction of duty cycle which reflects the load changes. **Results:** The results proved that third-order harmonic, which was the Lowest Order Harmonic (LOH), can be attenuated by adjusting the modulation index of the injected signal. Moreover, the rectifier shows a good transient performance where the converter's output voltage overshoots during load and input voltage transients is reduced. **Conclusions/Recommendations:** The proposed circuit can be used as a front-end converter for DC/DC or DC/AC converters in order to improve the power factor of the input current. Also the proposed control circuit could be integrated in a single chip in order to reduce the cost of the industrial implementation.

Key words: AC/DC converter, power factor correction, switched-mode power supply

INTRODUCTION

An ac to dc converter consisting of a line frequency diode bridge rectifier with a large output filter capacitor is cheap and robust, but demands a harmonic rich ac line current. As a result, the input power factor is poor. Due to problems associated with low power factor and harmonics, harmonic standards and guidelines, which will limit the amount of current distortion allowed into the utility, is introduced. Thus the simple diode rectifiers may not in use. To correct the poor power factor and reduce high harmonic current contents, passive and active circuits can be used. In general, active methods are more efficient, lighter in weight and less expensive than passive circuit methods^[1].

In active power factor correction techniques approach, Switched Mode Power Supply (SMPS) technique is used to shape the input current in phase with the input voltage. Basically in this technique power factor correcting cell makes the load behave like a resistor leading to near unity power factor. Figure 1 shows the circuit diagram of basic active power

correction technique^[2]. There are different topologies for implementing active power factor correction techniques including the boost converter^[2] and the buck converter. For reasons of simplicity and its popularity, the boost converter is used to improve the power factor.

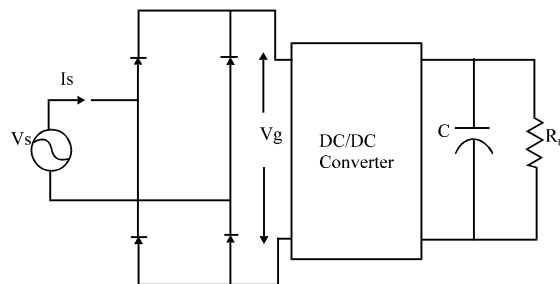

Fig. 1: Active PFC technique

In boost circuit, the switching device handles only a portion of the output power and this property can be used to increase the efficiency of the converter. The boost converter may be designed to operate either in the

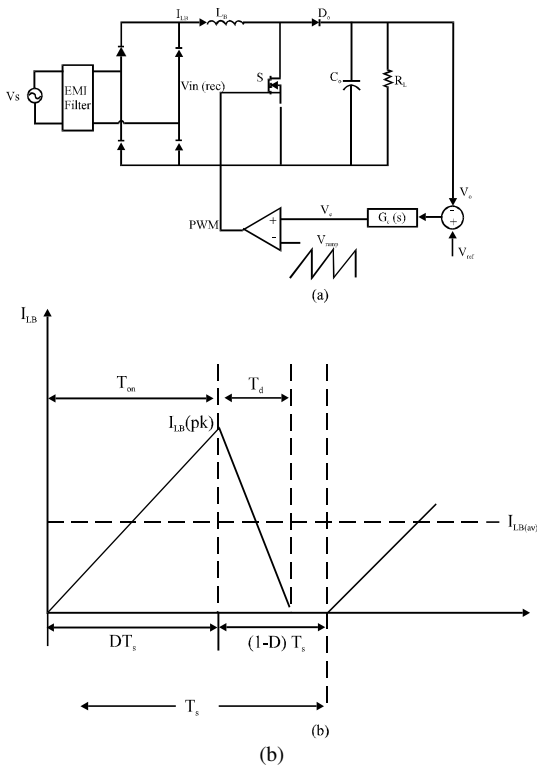

Fig. 2: Single-phase single switch DCM boost converter

Continuous Conduction Mode (CCM) or in the Discontinuous Conduction Mode (DCM). Compared with the CCM approach, a converter operating in DCM provides a simpler control scheme, which requires only one (voltage) control loop to modulate the on-time, Fig 2. Furthermore, operating a boost converter in discontinuous mode avoids the output diode reverse recovery problem and alleviates the high switching loss in continuous mode operation. One drawback of DCM PFC approach is that its input current waveform is not always purely sinusoidal. The input current will contain certain distortion due to the modulation of inductor current discharging time. This waveform distortion is found to be a function of the ratio of the peak line voltage to the output voltage of the PFC circuit.

Generally, to reduce the harmonic current contents of DCM boost converter, the duty cycle of the rectifier switch needs to be properly modulated during a rectified line period instead of being kept constant. Recently, a number of duty cycle modulation techniques for the DCM boost rectifier have been introduced to reduce the Total Harmonic Distortion (THD) of the input current for single-phase and three-phase systems^[3-8]. Specifically, the approach based on variable switching frequency control was presented and analyzed in^[7,8]. However, since the switching frequency

directly depends on the input voltage and output power variations, the variable switching frequency method suffers from very wide frequency range which decreases the efficiency and makes the rectifier design and control circuit more complex. To improve the performance of the DCM boost converter at constant switching frequency, harmonic injection methods have been introduced^[5,6], which gives high quality input current at the cost of complicating the control circuitry. Another important factor affecting the line harmonic distortion is the bandwidth of the output feedback control loop of the boost rectifier. Generally to achieve a low THD, the bandwidth must be well designed below the rectified frequency of the line, i.e., by keeping the bandwidth below 100 Hz for a line frequency of 50 Hz. As a result, the transient response of the control loop to line and load changes is very slow causing high transient overshoot in the output voltage.

The purpose of this research is to propose a new simple, low cost harmonic reduction method, which has the simplicity of voltage follower technique. In the proposed method a periodic signal proportional to the rectified ac line voltage is injected into the control circuit to modulate the duty cycle of the power switch, S, such that the THD of the line current is reduced and PF is improved. The proposed method offers the following: (a) the generation of the injected signal with unity amplitude is simplified by sensing the output voltage of the bridge rectifier V_g (Fig. 1). As a result, the additional circuit (phase detecting and phase-locking circuits), required to generate and synchronize the injected harmonic signal proposed in^[5] is eliminated, (b) To obtain nearly constant harmonic content over a wide range of load variation, a modulation index m is used to update the injected signal with a fraction of duty cycle (D) which reflects the load changes, (c) To improve the transient response the output voltage, a fraction of V_o is added to the triangular reference in order to compensate the fast changes in the input voltage and load and (d) Performs well over a wide range of the input voltage. Experimental and simulated results show the effectiveness of the proposed method.

MATERIALS AND METHODS

Analysis of the current Waveform distortion and brief review of previous harmonic reduction methods for DCM boost rectifier: The circuit diagram of the constant-switching frequency DCM boost converter and its typical inductor current are shown in Fig. 2a and b. The diode bridge rectifier is used to rectify the ac line voltage and the semiconductor power switch S, the inductor L and the output diode D_o operate as a boost chopper. The Power switch, S, is

operated at high switching frequency and the output voltage is regulated by varying the duty cycle of the switch, S. A capacitor C_o is used to reduce the ripple in the output voltage. The EMI input filter is used to filter out the high frequency components in the input current.

Figure 2, Single-phase single switch DCM boost converter In general, the input current in constant switching frequency boost converter is composed of a charging component and discharging component, as shown in Fig. 2. Assuming sinusoidal input voltage $V_s = V_m \sin \omega t$, the peak inductor current, $I_{LB(pk)}$, is determined as:

$$I_{LB(pk)} = \frac{V_{in(rec)} \cdot T_{on}}{L_B} = \frac{V_m |\sin \omega t|}{L_B} DT_s \quad (1)$$

Where:

- $V_{in(rec)}$ = The rectified line voltage
- T_s = The period of a switching cycle
- D = The duty cycle
- L_B = The inductance of the boost inductor
- T_{on} = The on-time of the boost switch S
- V_m = The magnitude of the input voltage.

According to (1) if the on time, i.e duty cycle D , is kept constant over a half line period, the peak inductor current follows an envelope of the input voltage (sinusoidal). However, the boost inductor current averaged over a switching period, $I_{LB(av)}$, which represents the line current, is distorted since from Fig. 2a it can be easily derived as:

$$I_{LB(av)} = \frac{D^2 T_s}{2L_B} \left(\frac{V_o V_m |\sin \omega t|}{V_o - V_m |\sin \omega t|} \right) \quad (2)$$

where, V_o is the output voltage. The distortion factor depends on the difference between output voltage V_o and the peak line voltage V_m . Eq. 2 can be rewritten as:

$$I_{LB(av)} = k \cdot \left(\frac{M |\sin \omega t|}{M - |\sin \omega t|} \right) \quad (3)$$

Where:

- $k = \frac{D^2 T_s V_m}{2L_B}$
- $M = \frac{V_o}{V_m}$ is the voltage gain.

Figure 3 shows the normalized line current waveform for a half cycle. It can be seen that when the

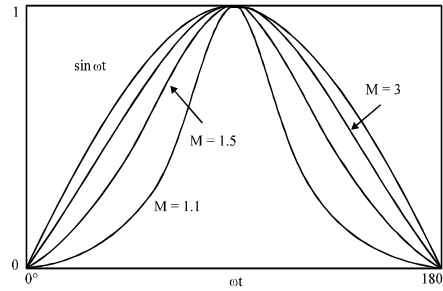

Fig. 3: Normalized line current waveform for half cycle

ratio M is large the current waveform is almost sinusoidal^[9]. However, for a given line voltage, a larger M means output voltage V_o is high, which will place a very large voltage stress on the boost switch S. The large voltage stress and high peak current stress (due to DCM operation) are often limiting factors that prevent the DCM boost converter from being used in high power rating circuits.

The performance of the constant switching frequency DCM boost converter can be significantly improved by employing the variable duty cycle control as described in^[3-5]. Lazar and Cuk^[3] describes a solution, where the distortion is reduced by modulating the duty cycle as given in Eq. 4:

$$d(t) = D \cdot \sqrt{1 - \frac{V_{in(rec)}}{V_o}} \quad (4)$$

where, D is the constant duty cycle in the absence of modulation. With the duty cycle modulation in Eq. 4, the line current distortion is very much reduced compared to those for constant duty cycle. In addition, this type of control makes it possible to maintain a power factor greater than 0.99 over a wide range of line voltage. However, the implementation of Eq. 4 is very complex because it requires an analog root mean square, multiplier and division. Hadley^[4] offers another solution, where the varying the duty cycle is achieved by modulating the PWM ramp with the ac component of the rectified line voltage. The modulating duty cycle for this method is given by:

$$d(t) = \frac{1}{\frac{1}{D} + a_m \left(|v_{in}(t)| - V_{in(pk)} \frac{2}{\pi} \right)} \quad (5)$$

However, the minimum line current distortion achieved using this method is around 10% and over modulation leads to an undesirable increase in 5th and 7th harmonic components. DeFeng Weng and Yuvarajan^[5] proposed modulating duty cycle with second harmonic of the line voltage. The second harmonic generated with a PLL circuit. Figure 4 shows

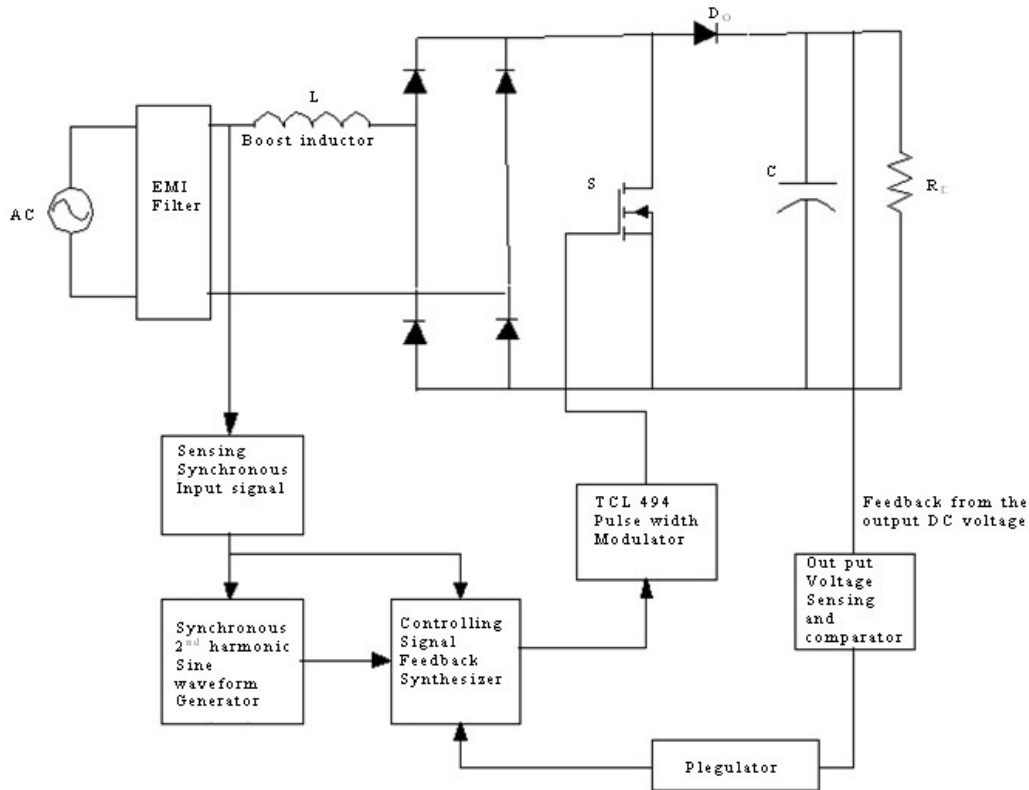

Fig. 4: Single-phase boost converter with second harmonic method

the concept. Using the second harmonic modulation, the time function of the duty cycle is given by:

$$d(t) = D + b_m \sin(2\omega t + \beta) \quad (6)$$

Where:

- b_m = The modulation index
- ω = The angular frequency of the line voltage
- β = A phase shift.

Actually the phase shift β must be well synchronized with the line current for successful harmonic reduction. This method provides very effective distortion reduction but requires complicated and expensive additional circuitry. In fact, it has a severe phase shift problem which requires phase-detecting and phase-locking circuits for reliable operation. In both methods proposed in^[4,5] the input current waveform changes with the load level, for a fixed input voltage. Consequently, the harmonic content also changes.

New low cost harmonic reduction implementation: Figure 5, shows the proposed harmonic reduction

method. A signal $d(t)$ proportional to the rectified line voltage is injected into the control circuit to modulate the duty cycle of the power switch, S, such THD of the line current is reduced and as a result the power factor is improved. This method is similar to the second harmonic modulation but requires much less additional circuitry (only resistors and one multiplier). It eliminates the need to employ phase detecting and phase-locking circuits to properly synchronize the injected signal with rectifier input current. The proposed harmonic injection technique uses a voltage signal which is proportional to the rectified ac input voltage. As a result, the injected signal is naturally synchronized with the input voltage. To obtain nearly constant harmonic content over a wide range of load variation, a modulation index m is used to update the injected signal $d(t)$ with a fraction of D which reflect the load changes. The modulation index circuitry is only two voltage divider resistors. To improve the transient response the output voltage, a fraction of V_o is added (the adder could be replace by an integrator to generate the triangular waveform) to the triangular reference in order to compensate the fast changes in the input voltage and load. It should be noted that during

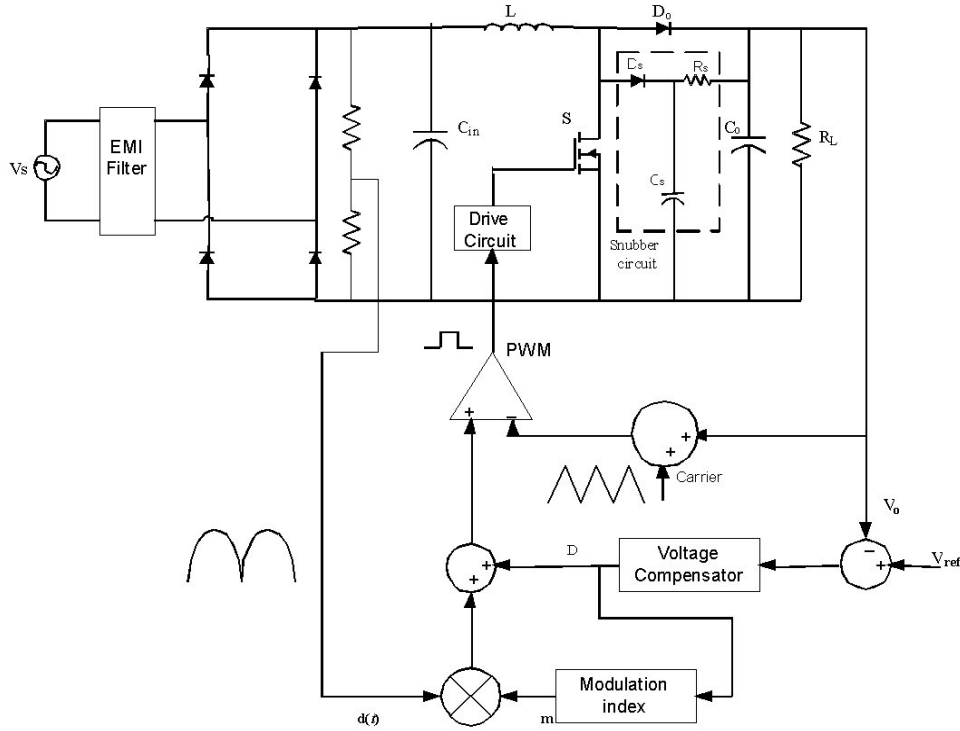

Fig. 5: Single-phase single switch boost converter with proposed modulated duty cycle

the transient changes, the output of the voltage compensator (error amplifier) does not change immediately because of the assumed low bandwidth of the voltage loop.

Therefore, to modulate the duty cycle of the power switch, we can employ the output of the diode bridge rectifier of the power stage, which contains a second-order harmonic and higher-order components such as 4th, 6th, 8th,...etc. Therefore the injected signal can be expressed as:

$$d(t) = m \sum_{n=2,4,\dots}^{\infty} \frac{-1}{\pi(n-1)(n+1)} \cos(n\omega t) \quad (7)$$

where, $0 < m < 1$ is the modulation index and ω is the input frequency. A filter capacitor, C_{in} , is placed between the bridge rectifier and the boost inductor L , in order to reduce the high frequency ripple of the injected signal. C_{in} can also reduce the peak inductor current due the DCM operation. The optimal value of m that results in a THD of less than 5% was found out through the simulation and later implemented in the experimental converter.

The modulation of the duty ratio during a line cycle can be expressed as:

$$D_{mod}(t) = D[1 + d(t)] \quad (8)$$

where, D_{mod} is the modulated duty cycle and D is duty cycle in the absence of the modulation. By substituting D in Eq. 6 with the modified duty cycle D_{mod} defined in Eq. 8, the average input current in the presence of the signal injection can be described as:

$$I_{in}(inj) = I_{in}(avg)[1 + d(t)]^2 \quad (9)$$

$$\therefore I_{in}(inj) \approx I_{in}(avg)[1 + 2d(t)]$$

where, $[d(t)]^2$ term is neglected, since it is much smaller than the unity. Since the third-order harmonic is the dominant harmonic with constant switching frequency PWM control, the input current can be approximately expresses as:

$$I_{in} = D^2 I_1 \sin(\omega t) + D^2 I_3 \sin(3\omega t) \quad (10)$$

where, I_1 and I_3 are the amplitudes of fundamental and the third component (assumed constant values). Substituting for D with the modified duty cycle D_{mod} and by setting $n = 2$ in Eq. 7 for the second-order

harmonic, since it has the highest magnitude, the input current in (10) can be rewritten as:

$$I_{in} = I_1 \left[1 + 2m \sin(2\omega t + (3\pi/2)) \right] \sin(\omega t) + I_3 \left[1 + 2m \sin(2\omega t + (3\pi/2)) \right] \sin(3\omega t) \quad (11)$$

Simplifying Eq. 11 yields:

$$I_{in} = (I_1 + mI_1 - mI_3) \sin(\omega t) + (I_3 - mI_1) \sin(3\omega t) - mI_3 \sin(5\omega t) \quad (12)$$

or

$$I_{in} = I'_1 \sin(\omega t) + I'_3 \sin(3\omega t) - mI_3 \sin(5\omega t)$$

Furthermore, if we consider the fifth-order harmonic in input current Eq. 10, the term $[-mI_3 \sin(5\omega t)]$ can reduce the amplitude of this harmonic component by small amount of $(-mI_3)$. Therefore, the Total Harmonic Distortion (THD) of the input current with the modulated duty cycle is given by:

$$THD' \approx \sqrt{(I_3 - mI_1)^2 + (mI_3)^2} / I'_1 \quad (13)$$

Obviously THD' with injection is much smaller than $THD \approx I_3/I_1$ without injection.

RESULTS

The performance of the harmonic reduction with harmonic injected PWM of a boost converter Fig. 5 was verified on both a simulation model and an experimental prototype with the following parameters:

- Input voltage: 106V/50Hz, Output voltage: 215V, Output power: 500W, Switching frequency: 20kHz, Input inductor: 130 μH, Output capacitor: 440 μF

In the experimental prototype, a MOSFET (IRFB22N50A) is used as the main switch. The input bridge rectifier is constructed using MUR1540 ultra fast recovery and DSEI60-10A is the output diode. The control circuit for harmonic injection is very simple. As shown in Fig. 5, based on the voltage compensator designed for constant switching frequency PWM, a synchronized harmonic signal with unity amplitude, which contains a second-order harmonic and higher-order components, is used. A multiplier is used to modify the amplitude of the signal with the modulation index and an adder is used to combine the injected signal with the voltage feedback. To improve the transient response the output voltage, V_o is added to the triangular reference in order to compensate the fast

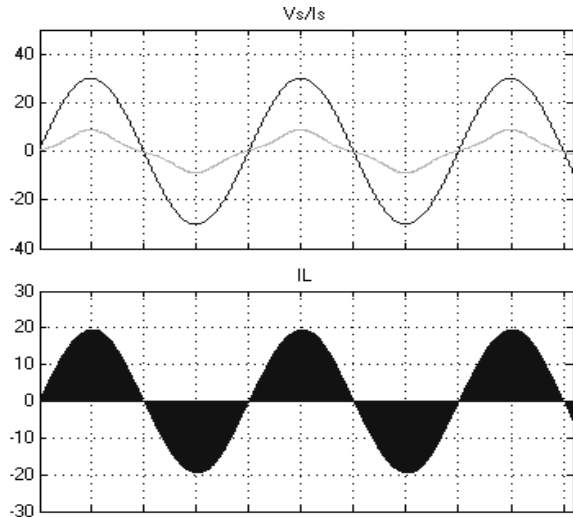

Fig. 6: Simulated input Voltage (scale 1:5), input current and the inductor current with constant duty cycle. ($P_o = 500$ W, THD = 20.25%)

changes in the input/output voltage. In the new control scheme, the PWM signal is obtained by monitoring the input and output voltages only. Since the power factor is a steady-state quantity, the dc output voltage and the rectified input voltage are used. There is no need to monitor the current as in the case of continuous current mode of operation. Thus the present method eliminates the use of a current sensor. Therefore, the monitor circuit is very simple. The converter was simulated using Matlab/Simulink for both constant and modulated duty cycle. The simulation results of the input voltage and current with constant duty cycle and output power of 500 W are presented in Fig. 6. The corresponding results with the proposed modulated duty cycle are shown in Fig. 7. The frequency spectrum of the input current for the modulated duty cycle is presented in Fig. 8. The corresponding experimental results are recorded using a digital storage oscilloscope and presented in Fig. 9-11. The results for an output power of 250W are presented in Fig. 12 and 13. It can be noted that the THD is kept nearly constant as the load changes. Fig. 14 shows the measured transient response of the output voltage for a step change in the load with and without the proposed method. The load was stepped up from 250-500 W. Figure 15 shows the transient response of the output voltage during input voltage transient test. In order to measure both the input and output voltages using simple probe voltage, a step

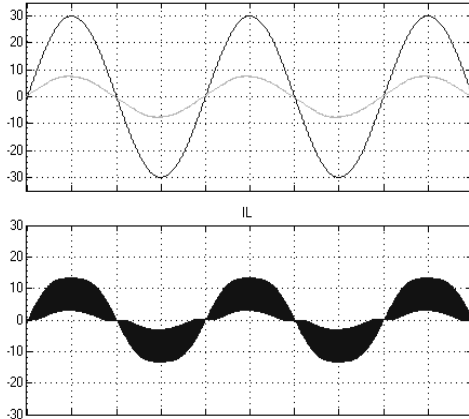

Fig. 7: Simulated input Voltage (scale 1:5), filtered input current and the inductor current with proposed duty cycle. ($P_o = 500$ W, THD 2.67%)

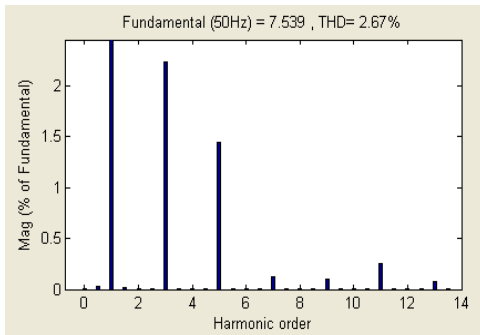

Fig. 8: Frequency spectrum of the simulated input current with the proposed duty cycle. (THD 2.67%)

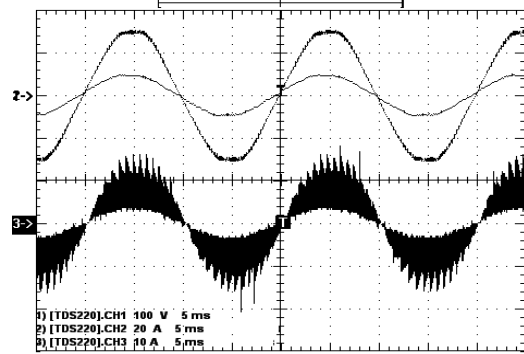

Fig. 10: Measured input Voltage, filtered input current and the inductor current with the proposed duty cycle. $P_o = 500$ W

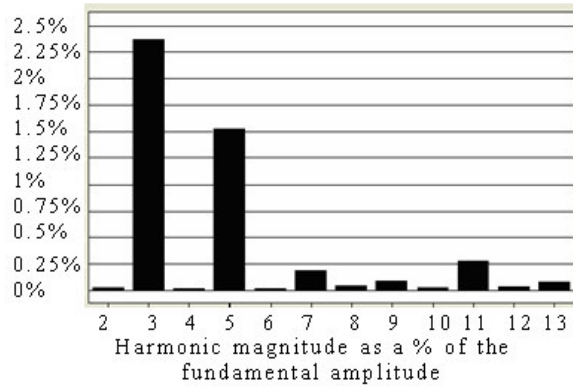

Fig. 11: Frequency spectrum of the measured input current with the proposed duty cycle, $P_o = 500$ W, THD = 2.87%

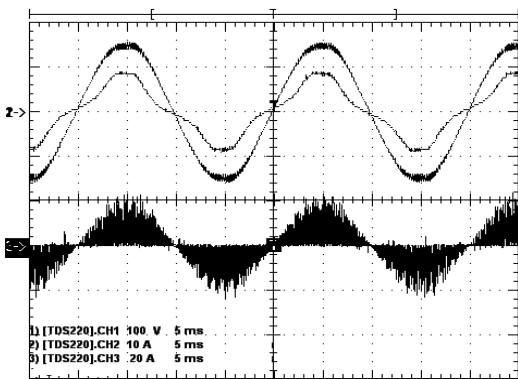

Fig. 9: Measured input Voltage, filtered input current and the inductor current with constant duty cycle. ($P_o = 500$ W THD = 20.89%)

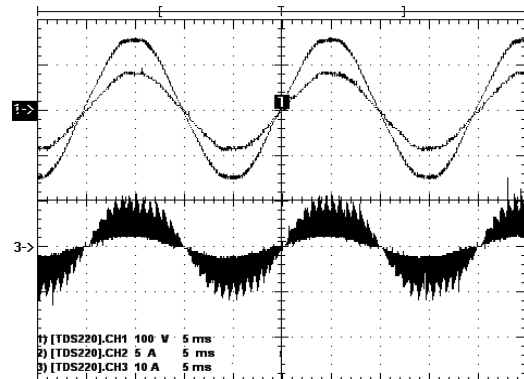

Fig. 12: Measured input Voltage, filtered input current and the inductor current with the proposed duty cycle. $P_o = 250$ W. (THD = 2.58%)

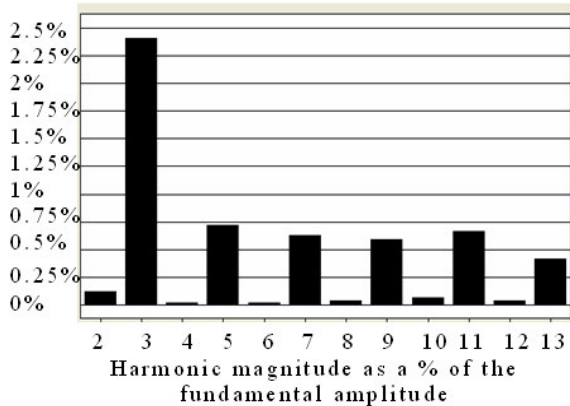

Fig. 13: Frequency spectrum of the measured input current with proposed duty cycle and $P_o = 250\text{ W}$, THD = 2.56%

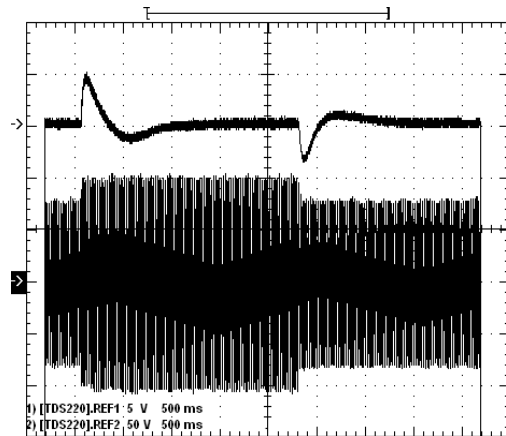

Fig. 15a: Line current and line voltage for step input voltage change with constant duty cycle

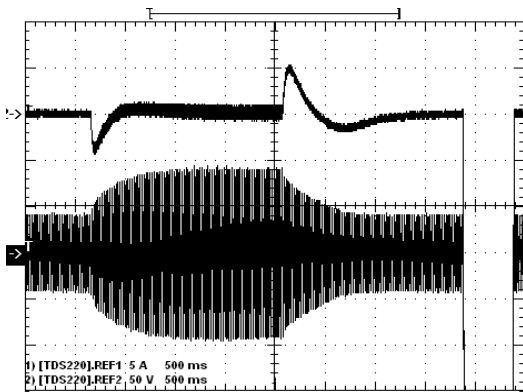

Fig. 14a: Line current and output voltage for step load change with constant duty cycle

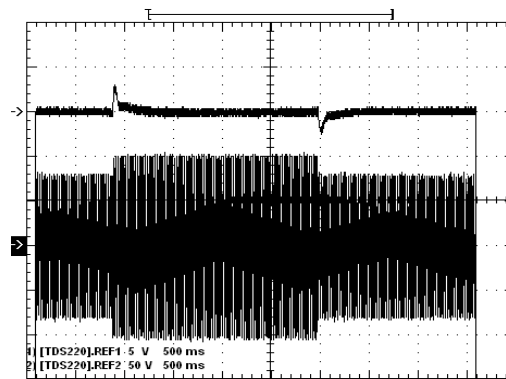

Fig. 15b: Line current and line voltage for step input voltage change with the proposed duty cycle

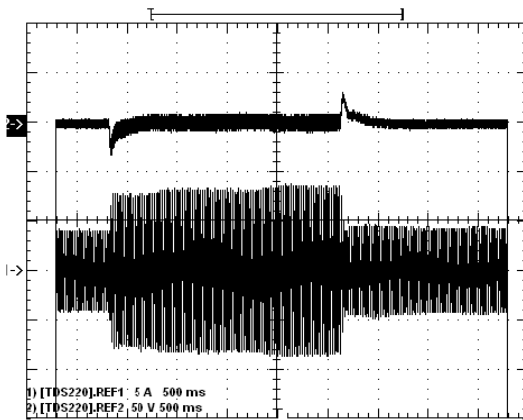

Fig. 14b: Line current and output voltage for step load change with the proposed duty cycle

down isolation transformer is used to measure the input voltage (to avoid having s.c). The input voltage was stepped up from 150-170 V (peak) for about 2 sec before is stepped back to 150 V.

DISCUSSION

Operating a boost converter in discontinuous current mode has one drawback, the input current will contain certain distortion due to the modulation of inductor current discharging time. This waveform distortion is found to be a function of the ratio of the peak line voltage to the output voltage of the PFC circuit, the higher the output voltage the lower will be the harmonics. However, In order to reduce the input current harmonics without increasing the output voltage, harmonic injection methods have been introduced^[5,6], which gives high quality input current at the cost of complicating the control circuitry. In this study a simplified harmonic injection method has been proposed. As it can be seen from Fig. 5, the injected signal, $d(t)$, is just two voltage divider resistors.

Furthermore, the addition of the modulation index circuit, which is voltage divider resistors only, results in approximately constant harmonic contents for a wide range of load. And this can be observed in Fig. 10-13. It is found that third-order harmonic, which is the Lowest Order Harmonic (LOH), can be attenuated by adjusting the modulation index (m).

The peak inductor current for discontinuous current mode of operation is usually high. However, using the capacitor C_{in} between the bridge rectifier and the boost inductor the peak current can be reduced. With modulated duty cycle and the capacitor C_{in} the inductor current could be continuous and this is one of the significant advantages of the proposed method. As we can see that the dominate third order-harmonic is attenuated using the modulated duty cycle. The value of THD is reduced below 3% (Fig. 11 and 13) and as a result the input power factor (0.9996) is improved. Generally to achieve a low THD, the bandwidth must be well designed below the rectified frequency of the line, i.e., by keeping the bandwidth below 100 Hz for a line frequency of 50 Hz. As a result, the transient response of the control loop to line and load changes is very slow causing high transient overshoot in the output voltage. Therefore, to improve the transient response, a fraction of the output voltage is added to the carrier waveform (Fig. 5). The results in Fig. 14 and 15 show the effectiveness of the proposed method.

Therefore, the proposed control circuit provide a low and approximately constant line current harmonic content with good transient response for a wide range of input/output voltage changes, which are very crucial for commercial applications.

CONCLUSION

The study reviews the topology, operation and analysis of the single-phase single-switch DCM boost rectifier using constant switching frequency control and determines the current distortion caused by the slow discharge of the inductor. The study proposes a simple, low cost harmonic injection analog controller to modulate the duty cycle of the boost switch such that the third-order harmonic of the input current is reduced and the overall THD is improved. It is found that third-order harmonic, which is the Lowest Order Harmonic (LOH), can be attenuated by adjusting the modulation index (m) shown in Eq.7. The high ripple inductor current of the DCM operation is reduced by using a suitable value of the capacitor C_{in} , which is optimized through the simulation model. It is found that C_{in} can reduce the THD by some extend and it makes the inductor current to be continuous. The injected duty cycle variations are naturally synchronized with the input voltage without using an additional harmonic generator and expensive phase-detecting, phase-locking

circuits. In addition, the rectifier shows a good transient performance which reduces the rectifier's output voltage overshoots during load and input voltage transients. Moreover, to obtain nearly constant harmonic content over a wide range of load variation, a modulation index m is used to update the injected signal with a fraction of duty cycle (D) which reflects the load changes. It is found that simulated and experimental results match closely. It is also found that the THD is less than 3%.

REFERENCES

1. Gracia, O., J.A. Cobos, R. Prieto and J. Uceda, 2003. Single-phase power factor correction: A survey. *IEEE Trans. Power Electron.*, 18: 749-755. DOI: 10.1109/TPEL.2003.810856.
2. Yang, Z.H. and P.C. Sen, 1998. Recent developments in high power factor switch-mode converters. *IEEE Can. Conf. Elect. Comput. Eng.*, 2: 477-488. DOI: 10.1109/CCECE.1998.685537.
3. Lazar, J. and S. Cuk, 1995. Open loop control of a unity power factor, discontinuous conduction mode boost rectifier. *Proceeding of the 17th International IEEE Telecommunications Energy Conference, '95*, pp: 671-677. DOI: 10.1109/INTLEC.1995.499030.
4. Ferdowasi, M. and A. Emadi, 2004. Estimative current mode control technique for DC-DC converters operating in discontinuous conduction mode. in *IEEE Power Electron. Lett.* 2: 20-23. DOI: 10.1109/LPEL.2004.830245
5. DeFeng Weng and S. Yuvarajan, 1996. Constant switching frequency AC-DC converter using second harmonic injected PWM. *IEEE Trans. Power Elect.*, 11: 115-121. DOI: 10.1109/63.484424.
6. Sun, J., N. Frohlike and H. Grotstollen, 1996. Harmonic reduction techniques for single switch three-phase boost rectifiers. *Proceeding of the 31st Annual Meeting, Conference Record of Industry Applications*, pp: 1225-1232. DOI: 10.1109/IAS.1996.560234.
7. Kang, Y., J.Y. Lin and S.Y. Ou, 2007. Switching frequency control for regulated discontinuous conduction mode boost rectifiers. *IEEE Trans Ind. Elect.*, 54: 760-768. DOI: 10.1109/TIE.2007.892104.
8. Simonetti, D.S.L., J. Sebastian and J. Uceda, 1993. Single switch three-phase power factor under variable switching frequency and discontinuous input current. *Proceeding of the IEEE Power Electronics Special Conference Record*, pp: 657-662. DOI: 10.1109/PESC.1993.471995.
9. Liu, K.H. and Y.L. Lin, 1989. Current waveform distortion in power factor correction circuits employing discontinuous mode boost converter. *Proceeding of the IEEE Power Electronics Special Conference Record, Milwaukee, WI, USA.*, pp: 825-829. DOI: 10.1109/PESC.1989.48565