

Design of Arm Based Real Time Personnel Monitoring System Using Wi-Fi Technology

¹Rekha George and ²Varghese Paul

¹Department of Electronics and Communication,

²Department of Computer Science and Information Technology,
Faculty of Engg., Toc H Institute of Technology, India

Received 2013-06-14, Revised 2013-07-05; Accepted 2013-07-23

ABSTRACT

Nowadays we constantly come across the need to transfer remote data to monitor center which will be far away from the place of data acquisition. Traditional data acquisition system using wires cannot satisfy these requirements due to its heavy cost and impracticability. Embedded devices with network communication which makes it more powerful and easier to monitor and control remote data, is one of the major outcomes of the developments in the field of communication and networking technologies. This study presents the design of a real time personnel monitoring system based on wireless technology. ARM embedded processor and Wi-Fi module are used as hardware platform in this project. Data transfer over the wireless network is based on the TCP/IP protocol which is a part of the Wi-Fi module. Using this designed system an officer can monitor the personnel in the organization by opening a web page from a place that is geographically far. This system is based on the conversion of serial to wireless data which could be transferred over the wireless network to the server and also over the internet. At the completion of the design, the result shows that data is transferred between the ARM processor and the host system using the wireless network.

Keywords: ARM Processor, Ethernet, SPI Device, RFID, GSM, Wi-Fi, Interface

1. INTRODUCTION

As the internet usage is increasing day by day and humans are looking into ways to reduce the time and effort for various tasks, it is advisable to give direct access to what they need to monitor and control. Transmission of data over network is economical, efficient and faster now than in olden times (Ruimei and Mei, 2010). An embedded system is housed on a single microprocessor and the control logic of many of them are implemented as a single program (Lu *et al.*, 2010). It is widely used in Consumer market, Communication, Industrial fields, Biomedical Applications, since it is highly reliable with small size and very low power consumption. Earlier Ethernet, which is a networking technology which is used to share and communicate resources and embedded systems where lying in two different worlds.

But development of technology has enabled us to do remote monitoring and controlling using an

embedded system connected to Ethernet (Yang *et al.*, 2009). By connecting Ethernet device to a router/Access point we can also transfer data over the internet. By embedding a web server into the device various parameters can be accessed using a web browser from a remote place. A lot of research was done in the area of embedded ethernet interface in the past couple of years.

In this design data is collected automatically by avoiding human intervention and is transferred over the wireless network using the Wi-Fi technology based on TCP/IP protocol. The wireless data transmission between embedded devices and wireless monitoring system can be resolved easily and therefore the cost of networking and maintenance is minimized (Lu *et al.*, 2010). In this ARM-based system the data is collected using RFID Scanner and it will be kept in the database of the host system. Thus we can avoid the wastage of memory of the embedded device. Also, RFID which is a short range

Corresponding Author: Rekha George, Department of Electronics and Communication, Faculty of Engg.,
Toc H Institute of Technology, India

device is indirectly converted into a long range device by connecting to the embedded device with Wi-Fi connectivity (Lu *et al.*, 2010). A person at a remote place can access the data using a web browser, by communication with the host system which acts the server. Only a valid user can access the system which is checked by the system.

2. MATERIALS AND METHODS

A modular design approach is used in the system design. The main modules of the system are RFID reader, Processor module, GSM module and Wi-Fi module. Wireless networking is used because of less installation charges and since network expansion and reconfiguration is less complicated than a wired network (Lu *et al.*, 2010). The system will process the data from the reader and will send a message to the person-in-charge in case of absence. The basic system structure is shown in **Fig. 1**. In this system the data read by the wireless terminal is processed and send to the server where it is stored in the database. According to the requirement of the client it is displayed on the client monitor. In case of absence of the personnel who is under scrutiny message is sent to the person-in-charge.

The Wireless terminal shown in **Fig. 2** consists of Processor, RFID reader, an LCD display and the wireless module.

2.1. Processor Module

Phillips LPC2129 is an ARM7TDMI-S based high-performance 32-bit RISC Microcontroller with 256 KB on-chip Flash ROM, 16KB RAM and low power consumption. It is very powerful and its cost is same as lower performance 8-bit microcontrollers and its memory capacity makes it ideal for implementing stack which needs much memory. High performance, low power, low cost, high throughput, excellent real-time interrupt response, small size and memory capacity are the main characteristics of ARM processor (Babu *et al.*, 2011). ARM development Kits are available at low price and many Software Development Tools are available for this processor. The data read by RFID reader is transferred to the processor through UART which can be displayed over LCD. The data that is to be send to the Wi-Fi module is packaged according to the frame format and Wi-Fi module will transform the data into wireless data sequence and send out automatically.

Development board with LPC2129 Phillips microcontroller which is a powerful platform for embedded design is used in this project. It is normally used for the development of real time data monitoring

and control, high speed wireless communication, USB based data logging.

2.2. RFID Module

RFID tags are used to store maximum of 2KB of data which can be read by a RFID reader and is used to send the data to the processor for further processing. RFID tags are better than bar codes because of its capability to read and write. Data that is stored within an RFID tag's microchip. The tags are classified into three according to whether it has on-tag power source or not. They are active, semi-active and passive RFID tags. This is based on their range, frequency, memory, security, type of data and other characteristics. The characteristics of RFID tags are based on its range, frequency, memory, security and type of data (Ahsan *et al.*, 2010). The electromagnetic energy radiated by the RFID reader's antenna is received by the Tag's antenna. Radio waves will be sent back to the reader by the tag using its internal battery power or the power of the electromagnetic field of the reader. The reader in turn will pick up the radio waves from the tag and will extract the meaningful data from its frequencies.

Here the tag is used to identify a person and his entry and exit times are entered in the database. RFID is fast, efficient and readily available. The RFID reader module is connected to the Processor using UART interface. The baud rate selected is 9600 and the format for data transfer is 8 data bits with 1 stop bit and no parity bit.

2.3. GSM Module

GSM Global system for mobile communication is a standard set developed by the European Telecommunications Standards institute to describe protocols for second Generation (2G) digital cellular networks used by mobile phones. The data is compressed and digitized by GSM and is send with two other streams of data down the channel with different time slot. In GSM, the account information of the user is stored in a Subscriber Identity Module (SIM) which is a smart card. Any GSM phone becomes immediately programmed after plugging in the SIM card. GSM includes the Short Messaging Service (SMS) that enables users to send 160-character text messages to each other. GSM networks operate in different carrier frequency ranges with most 2G GSM networks operating in the 900 to 1800 MHz bands. The GSM module is connected with the processor module using UART interface. The application software will send a message to the person-in charge as soon as identification code of the person he is monitoring is recognized by the reader.

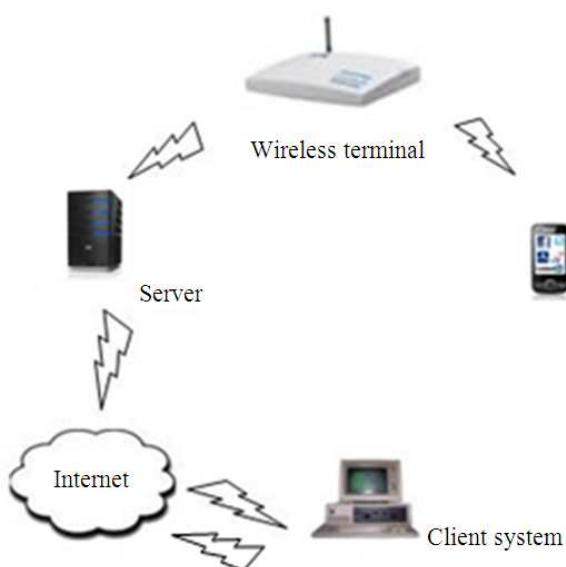

Fig. 1. Basic system structure

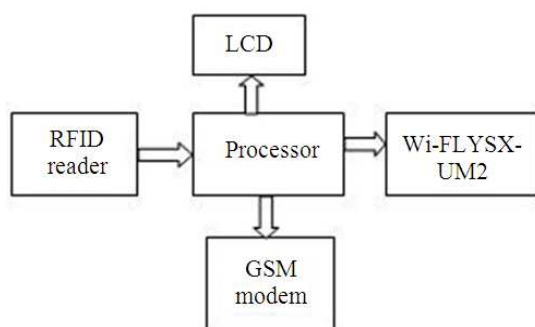

Fig. 2. Wireless terminal

2.4. Wi-Fi Module

Wireless solutions are more cost-effective than wired solutions and deployment is easier, even in the most challenging locations. Major advantages of Wi-Fi are convenience, flexibility, mobility, practicality and portability. Wi-Fi also provides high transmission rate, convenient networking, strong anti interference capability and low price (Jiahui *et al.*, 2011). Two main types of wireless technologies are cellular and Wi-Fi. Cellular is often deployed in extreme and harsh industrial environments. Wi-Fi offers faster transfer speeds than cellular does, but it has a very limited range of 150-300 ft, depending on the type of equipment, Wireless-Local-Area-Network (WLAN) protocol being used and also depends on whether the solution is an indoor or outdoor deployment. Here, the data to be transferred over the

wireless network is transferred to the Wi-Fi module using serial interface. Wi-Fi networks have limited range and high power consumption. The coding technique used in Wi-Fi 802.11 g is orthogonal Frequency Division Multiplexing (OFDM). **Table 1** shows the characteristics of various other Wi-Fi technologies. 802.11 n is backward compatible with a, b and g standards and it can achieve speeds as high as 140Mbps. It can transmit up to four streams of data, each at a maximum of 150 Mbps. Wi-Fi is capable of splitting the radio bandwidth, which is available into dozens of channels so as to frequency hop rapidly between them and thus it will become immune to interference. When data transfer is slower, flooding of the wireless connection and subsequent retry requests which occurs when a network client begins to fall behind on processing its messages are avoided over long distances using reliable connection. A wireless range extender can be used to increase the distance covered by a WLAN signal. An extender overcomes the obstacles and the overall network signal quality is enhanced.

In this design the Wi-Fi module receives the data from the data reading equipment using its serial communication interface. Since we are using 802.11 n compliant Wi-Fi module, maximum data rate is 248Mbps with less interference. The Wi-Fi radio module is a complete standalone wireless LAN access device. The device has onboard TCP/IP stack and applications Wi-FLY, 2011. Its wireless data rate is 54Mbps with high throughput. It can not only be integrated into embedded devices because of its small size but also accomplish data transmission and network connectivity.

Each Wi-Fi frame with frame format as shown in **Fig. 3** consists of a MAC header, Payload and a frame check sequence. The first two bytes of MAC header specifies the form and function of the frame. Each frame can have a maximum of four address fields which includes the MAC addresses of transmitter and receiver. The maximum size of the frame is 2346. When wireless encryption schemes like Wireless Encryption Protocol (WEP) or Wi-Fi protected Access (WPA) are applied to the frame, the Payload size will vary accordingly.

The Wi-Fi-module connects the user terminal/processor with the wireless LAN network. UART interface is used to connect the terminal and the Wi-FlyGSX-UM2 module. The communication between the server and Wi-FlyGSX-UM2 is based on TCP/IP protocol and its stack is a part of this module. The data encryption scheme used is WPA2-PSK. This pre-shared key mode is designed for small networks which do not require the complexity of an 802.1X authentication server Wi-Fly, 2011. Wi-FlyGSX-UM2 needs only ultra low power i.e., in sleep mode it needs 4 μ A, 40 mA for reception and a maximum of 210mA for transmission.

Table 1. Characteristics of Wi-Fi technologies

Wi-Fi technology	Freq.	Max. Data rate	Modulation technique
802.11a	54	5.0	OFDM
802.11b	11	2.4	HR-DSSS
802.11g	54	2.4	OFDM
802.11n	248	2.4/5	OFDM

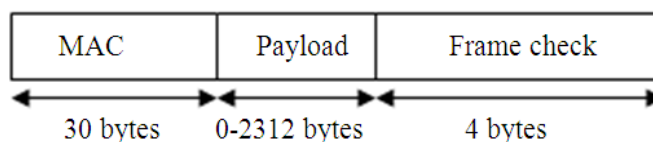

Fig. 3. Wi-Fi frame format

The source RTOS used is eCos or embedded configurable operating system which is designed for systems with memory size in the tens and hundreds of kilobytes.

2.5. UART Interface

The serial communication interface UART is used for transferring data between processor module and RFID reader/ GSM Modem/Wi-Fi module. It is one of the basic interfaces with advantages like less cost, simplicity and which is highly reliable for communication between controllers or a controller and a PC. UART is an abbreviation of universal asynchronous receiver and transmitter which is usually used in conjunction with communication standards like RS-232. UART takes bytes of data and transmits the individual bits in a sequential fashion. 8-bit shift register (Lu *et al.*, 2010) in UART is used for conversion between serial and parallel forms. Communication will be in simplex, half-duplex or duplex forms. All the operations of the UART are controlled by a clock signal which runs at a multiple of data rate. For fast processing, most UART chips have a built in buffer which is 16 to 64 kilobytes in size. This buffer is used for caching data that is coming in from the system bus while the data that is going out to the serial port is still being processed. The concept of Flow control is a very important aspect of serial communication. It is the capability of a device to tell another one to stop sending data for a certain time. The commands Request to Send (RTS), Clear To Send (CTS), Data Terminal Ready (DTR) and Data Set Ready (DSR) is used to enable flow control.

The data frame format of UART is shown in Fig. 4 and its interface with Microcontroller in Fig. 5.

2.6. Software Design

2.6.1. The Wi-Fi Wireless Communication Module

The design of application software includes the data transfer from the data acquisition system to the ARM module using the embedded software, application software to read the data and storing in the database and the client side software which reads data from the database. The data transferred over the wireless network is protected using Wire-less Protected Access-Pre-Shared Key mode (WPA-PSK) protocol. This authentication mechanism uses some form of credentials of the users to verify that they should be allowed to use the network or not. The WPA-PSK encrypts the network data using a 256 bit key.

2.7. Embedded Software

The functions of embedded software are reading the data from a valid user and transferring that to the wireless module. The data and time of entry/exit of a particular person will be based on the real time clock of the microcontroller. At the time of exit the data stored in the memory is transferred to the wireless module using serial interface with a set data rate.

2.8. Application Software-Server Side

The application software on the other hand will create a TCP connection and keeps on listening to the port and as soon as data is available it will be read and stored in the database of the server. The memory of the embedded device is not used for storage rather server with a larger memory capacity is made use of.

Database is developed using MySQL database server which fast, reliable, scalable and easy to use relational database management system which runs as a server.



Fig. 4. UART frame format

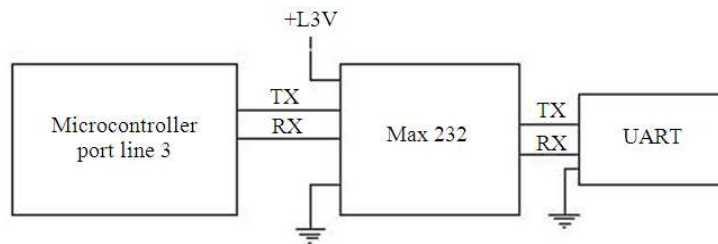

Fig. 5. UART interface

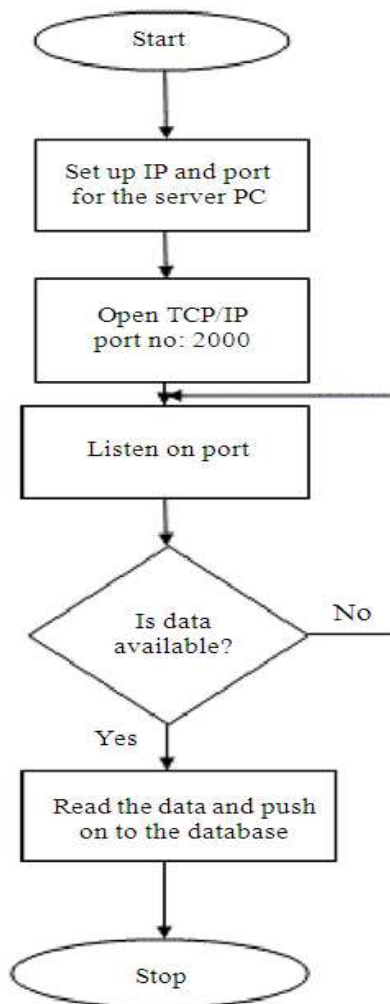

Fig. 6. Flow chart of server program

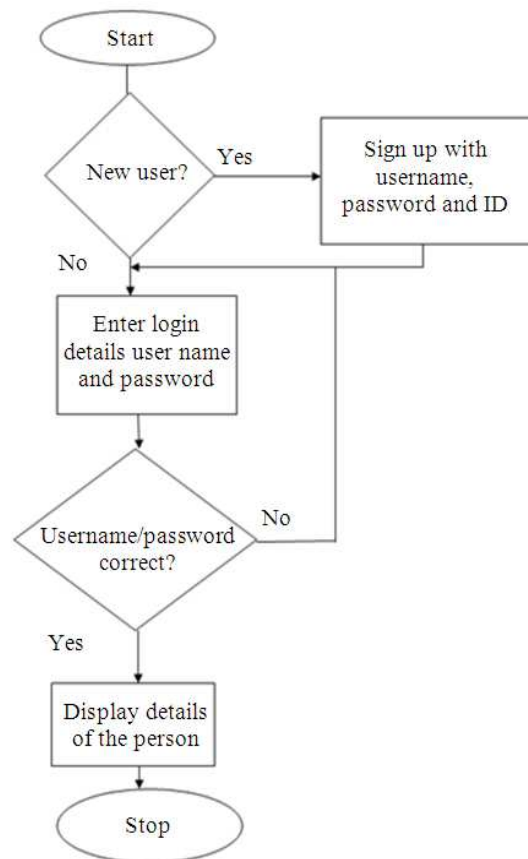

Fig. 7. Flow chart of client side program

The application software is written in JAVA. Java, which is robust, portable, with high performance and familiarity with write once run anywhere environment that made it the most apt embedded software

developing language. The flowchart of application software is shown in Fig. 6.

2.9. Client-Side Software

Using the client side software a new user can be added in the list of valid users and then on he/she can retrieve the monitoring details of the personnel by entering an IP address. The client side software will be listening to the server port using a TCP connection and as soon as a valid user enters the related data will be transferred to the client side. The flow chart of this is Fig. 7.

3. RESULTS

The result shows that the data is transferred to the server over the Wi-Fi network, stores it in the database and is accessed by the client whenever needed. The user interface for a new user to sign up is shown in Fig. 8. Figure 9 shows the details of the people under client's scrutiny for a particular day as per his request. The wireless data transfer rate is 54Mbps and the advantages of the system are low power consumption, convenient, low cost and high data rate.

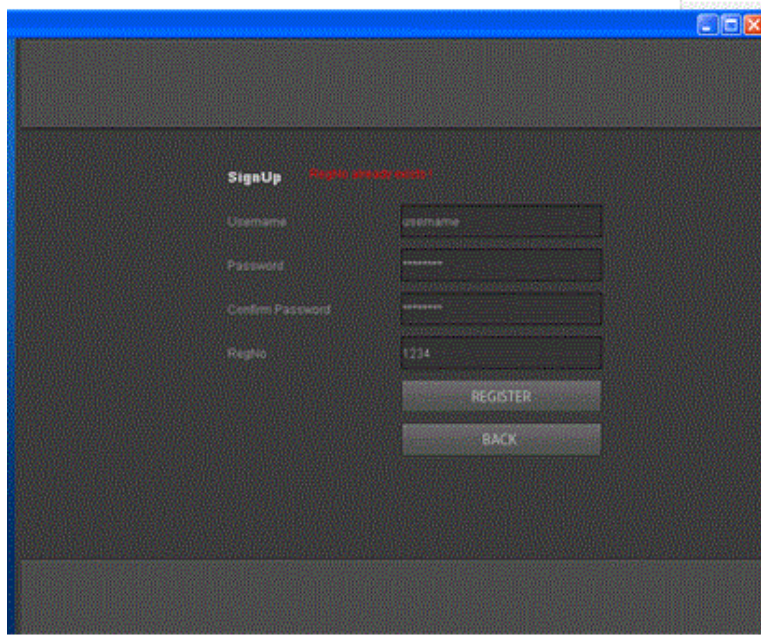

Fig. 8. User interface to sign up

id	regNo	Name	Department	CheckIn	CheckOut	Date
120	1028	Adithyan	Development	09:30	04:05	6/5/2013
121	1044	Dilipth	Account	09:32	04:10	6/5/2013
122	1042	Sandya	Development	09:33	04:10	6/5/2013
123	1003	Amith	Development	09:33	04:15	6/5/2013
124	1066	Krishnakumar	HR	09:36	04:18	6/5/2013
125	1052	Rethi	Account	09:37	04:18	6/5/2013
126	1047	Arjun Lal	Development	09:40	04:20	6/5/2013
127	1102	Vishnu Kumar	Development	09:40	04:30	6/5/2013
128	1021	Megha	Account	09:41	05:04	6/5/2013
129	1011	Dileep	Account	09:42	05:10	6/5/2013

Fig. 9. Log in details

4. DISCUSSION

The maximum data rate we are getting using this design is 54Mbps which need to be further improved. Another point to be noted is that RFID tag can be misused so we have to use a method which will avoid that. As our functionality increases instead of ARM7 we will have to use higher version of the processor.

5. CONCLUSION

Data acquisition and monitoring from a geographically distant place, which needed a lot of human intervention can be made faster, reliable and less costly using the designed system. The system is compatible with IEEE 802.11n which is more throughput and range than other wireless technologies like Bluetooth. Bluetooth and Zigbee consumes less power than Wi-Fi. We can lessen the amount of power by allowing the Wi-Fi subsystem to turn-off when not in use. In order to avoid the transferring and usage of RFID card by a wrong user, we can use biometric devices.

6. REFERENCES

- Ahsan, K., H. Shah and P. Kingston, 2010. RFID Applications: An introductory and exploratory study. *Int. J. Comput. Sci.*, 7: 1-7.
- Babu, T.R., K.V.V.S. Murthy and G. Sunil, 2011. AES Algorithm Implementation using ARM Processor. *Proceedings of the 2nd International Conference and Workshop on Emerging Trends in Technology, (ETT' 11)*, pp: 24-29.
- Jiahui, W., L. Xiaodan, Z. Lei and H. Weiyang, 2011. The design and implementation of a wireless meter reading system. *Proceedings of the 10th International Conference on Electronic Measurement and Instruments*, Aug. 16-19, IEEE Xplore Press, Chengdu, pp: 115-120. DOI: 10.1109/ICEMI.2011.6037692
- Lu, X.C., J. Huang, M.C. Wu, X.F. Liu and Y. Ding, 2010. IP-based connectivity with IEEE 802.11 embedded networks. *Proceedings of the 2nd International Conference on Information Science and Engineering*, Dec. 4-6, IEEE Xplore Press, Hangzhou, China, pp: 2147-2150. DOI: 10.1109/ICISE.2010.5688538
- Ruimei, Z. and W. Mei, 2010. Design of ARM-based embedded ethernet interface. *Proceedings of the 2nd International Conference on Computer Engineering and Technology*, Apr. 16-18, IEEE Xplore Press, Chengdu, pp: V4-268-V4-270. DOI: 10.1109/ICCET.2010.5485599
- Yang, R., H. Cai and M. Zhang, 2009. Research and Implement of Ethernet interface Based on embedded system. *Proceedings of the 2nd International Symposium on Computational Intelligence and Design*, Dec. 12-14, IEEE Xplore Press, Changsha, pp: 288-291. DOI: 10.1109/ISCID.2009.218